

Radio Engineering Industries
HD6-Series
Mobile Digital Video Recorders

Hardware User Manual
Hardware Installation Manual



HD6-Series Mobile DVR

Table of Contents

List of Figures.....	4
Introduction.....	6
Features.....	6
Specifications.....	7
System Overview.....	9
Front and Back Panels	11
Live View.....	13
Initial Set Up.....	13
Removable HDD and SD Card	14
DVR Loading and Unloading	14
SD Card Loading and Unloading.....	15
HDD Record Times	16
Long Term Storage	17
Installation.....	18
External Record Indicator / Event Mark Button Harness	20
GPS Antenna Module Harness	21
Vehicle Sensor Options Harness.....	22
Vehicle Sensor Options Harness Vehicle Connections	23
On-Screen Information with Vehicle Sensor Options Harness	24
Accelerometer Module Harness.....	25
Physical Mounting Requirements	26
L Bracket Mounting.....	26
Security Cover Mounting	27
Camera Placement	28
System Start-Up.....	28
System Shut Down.....	28
Playback Options	29
TV Video Outputs.....	29
Removable HDD and SD Card.....	29
PC Network Connection	29
REI Toolkit	31
REI Toolkit Dongle Connection.....	31
Connecting to an Android™.....	32
Connecting to an iPhone™.....	32
Auto Local/Manual Remote.....	32
Logging In.....	33
SD Card Function	34
Logging Out	34
Menu Configuration	35
Main Menu Page	35

HD6-Series Mobile DVR

Setup Menu	35
System Setup Menu	36
ID Menu.....	36
Time & Date Menu.....	37
Start Up Menu.....	38
Faults Menu	39
Password Menu.....	40
Video Setup	41
Camera Menu.....	42
IP and Port Setup Menu.....	43
Network Setup Menu	44
Alarm Menu.....	44
SD Menu.....	45
Sub-Stream Menu	46
Image Menu	46
Motion Menu	47
OSD Menu.....	49
Input Setup.....	49
Speed Menu	50
Inputs Menu	51
Accel Menu.....	52
GPS Port Menu	53
Network Setup	55
WAN/LAN Setup	55
Server.....	56
WIFI Menu	57
Cellular	58
Route.....	58
Firewall.....	59
Info.....	60
Camera.....	60
Inputs	60
Alarms	61
System	61
WAN/Cell.....	62
WIFI.....	62
Versions	63
Logs	63
Advanced.....	64
Server.....	65
Maintenance	65
Firmware.....	65
Config Menu.....	66
File Data	66
Storage.....	67
Live	67
Info Button.....	67
Settings button	68
Channel Selection	68
Play Back	68

HD6-Series Mobile DVR

Video (Time/Date Search).....	69
Alarm.....	69
FCC Statement.....	71

List of Figures

Figure 1: HD6-600-Series MDVR System Diagram.....	9
Figure 2: HD6-1200-Series MDVR System Diagram.....	10
Figure 3: Front Panel Layout (HD6-600 Shown).....	11
Figure 4: Rear Panel Layout (HD6-600).....	12
Figure 5: Rear Panel Layout (HD6-1200).....	13
Figure 6: Removable Hard Drive Module.....	14
Figure 7: Removable SD Card.....	15
Figure 8: Estimator for HDD Record Times (HD5 shown).....	16
Figure 9: System Wiring - Power and Camera Cables (HD6-600).....	18
Figure 10: System Wiring - Power and Camera Cables (HD6-1200).....	19
Figure 11: External Record Indicator/Event Mark Button Harness Connection.....	20
Figure 12: GPS Antenna Module Harness Connection.....	21
Figure 13: Vehicle Sensor Options Harness Connection.....	22
Figure 14: Accelerometer Module Harness Connection.....	25
Figure 15: 3 Axis Inertia Sensor Directions.....	25
Figure 16: L Bracket Mounting.....	26
Figure 17: DVR Dimensions.....	27
Figure 18: Security Cover Mounting.....	27
Figure 19: Connecting to the DVR with a Computer through the Ethernet Connection..	29
Figure 20: Initial DVR Window.....	33
Figure 21: Login Window.....	33
Figure 22: Logout Window.....	34
Figure 23: Main Menu.....	35
Figure 24: Setup Menu.....	35
Figure 25: System Setup Options.....	36
Figure 26: ID Menu.....	36
Figure 27: Time & Date.....	37
Figure 28: Custom DST Triggers.....	38
Figure 29: Start Up Menu in Ignition Mode.....	38
Figure 30: Record Schedule Menu.....	39
Figure 31: Faults.....	39
Figure 32: Password.....	40
Figure 33: Video Setup.....	41
Figure 34: Camera – Camera Setup.....	42
Figure 35: Custom Record Settings.....	42
Figure 36: IPC Setup Pop-up Window.....	43
Figure 37: Individual Channel Network Setup.....	44
Figure 38: Alarm Setup.....	44

HD6-Series Mobile DVR

Figure 39: SD Setup.....	45
Figure 40: Sub-Stream Setup.....	46
Figure 41: Image Setup.....	46
Figure 42: Motion Setup.....	47
Figure 43: Motion Setup - Set Grid.....	48
Figure 44: OSD Setup.....	49
Figure 45: Input Setup.....	49
Figure 46: Speed Setup.....	50
Figure 47: Inputs Setup.....	51
Figure 48: Input Setup - Custom.....	51
Figure 49: Accelerometer Setup.....	52
Figure 50: Accel Alarm.....	53
Figure 51: Accelerometer Threshold.....	53
Figure 52: GPS Port.....	53
Figure 53: Network Setup.....	55
Figure 54: General Network Setup.....	55
Figure 55: Server.....	56
Figure 56: WIFI Setup.....	57
Figure 57: Cellular Setup.....	58
Figure 58: Route Setup.....	58
Figure 59: Firewall Setup.....	59
Figure 60: Info Menu.....	60
Figure 61: Camera Tab.....	60
Figure 62: Inputs Tab.....	60
Figure 63: Alarms Tab.....	61
Figure 64: System Tab.....	61
Figure 65: WAN/Cell Tab.....	62
Figure 66: WIFI Tab.....	62
Figure 67: Versions Tab.....	63
Figure 68: Fault Logs Tab.....	63
Figure 69: Logs – Search Result System Logs.....	64
Figure 70: Advanced Tab.....	64
Figure 71: Server Tab.....	65
Figure 72: Upgrade Firmware.....	65
Figure 73: Export Configuration.....	66
Figure 74: File Data Tab.....	66
Figure 75: Storage Tab.....	67
Figure 76: Live Menu.....	67
Figure 77: Channel Bar.....	67
Figure 78: Sample Info Data Table.....	68
Figure 79: Channel Selection Buttons.....	68
Figure 80: Playback Menu.....	68
Figure 81: Video Tab - Time/Date Search for Date.....	69
Figure 82: Alarm Tab - Alarm Search.....	69

HD6-Series Mobile DVR

Introduction

This manual intends to provide information required for proper installation, initial setup, and explanation of the individual programming options pertaining to the HD6 Series Mobile DVR surveillance system. For assistance or to answer any questions call:

24 HOUR SERVICE HOT LINE
USA & CANADA
1-877-726-4617 Toll Free
1-402-339-2200

The HD6-Series is a cost effective, embedded mobile DVR solution supporting up to 4 analog camera inputs and 2 IP camera inputs for HD6-600. For HD6-1200, there is up to 8 analog and 4 IP camera inputs. This system features a unique compact rugged design engineered to meet the demands of harsh mobile environments. The HD6 mobile DVR features the latest technologies including H.264/MPEG-4 Advanced Video Compression, dual streaming technology, and all solid-state construction.

Features

- High Definition (1080p) on All Channels
- Ultra HD (4k) Channels
- GPS
- 4G Cellular (optional)
- Fast 802.11n Wi-Fi
- Optional Panic Button
- Full-Frame rate up to 30fps/Channel
- H.264 / H.265 Triple Streaming
- Optional Accelerometer
- Up to 2TB Hard Drive or optional Solid State Hard Drive
- Up to 256GB SD Card (optional)
- Optional Lockbox
- Extruded aluminum chassis
- Internal ACC
- Fanless design

HD6-Series Mobile DVR

Specifications

Power: 8 to 32 Volts DC, <2A operating (excludes cameras, accessories)

Dimensions: Without brackets: 7.4" x 3.2" x 9.5"; with brackets: 9.1" x 4.0" x 9.5" (max)

Weight: 8.6 lbs. (3.90 kg) with mounting brackets

Standby Current: < 2mA

Operating Temperature: -40°-+160°F continuous operation

Operating Humidity: 10% - 95%, non-condensing

Video Recording

Video Inputs: Up to 6 Channels (HD6-600), 12 Channels (HD6-1200)

Video Standards: NTSC, AHD, & REI

Resolution: Up to 1080P Channels 1-4 (HD6-600), 1-8 (HD6-1200); Up to UHD (4K) Channels 5 & 6 (HD6-600), 9-12 (HD6-1200)

Frame Rate: Up to 30 fps per channel

Bit Rate: 40 Mbps (HD6-600), 80 Mbps (HD6-1200)

Compression: H.265 Triple stream encoding/ recording – high quality recording + efficient network video streaming

Audio Inputs: 6 (HD6-600), 12 (HD6-1200)

Total Channels: 6 (HD6-600), 12 (HD6-1200)

Storage

Hard Drive: Removable hard disk or solid-state drive module with USB 3.0 interface, integrated shock and vibration dampening, and heater

Expandable Storage: eSATA port for external storage expansion (external HDD) – up to 16TB of total internal/external storage

SD Card: SD slot for simultaneous (mirror) or alarm video recording

Communication Module

Easily Upgradeable Communication Module: Field or factory installed removable communication module

WIFI (internal): Optional 802.11a/b/g/n 2.4Ghz/5Ghz Wi-Fi (Wi-Fi models only)

Cellular (internal): Optional 4G modem for cellular connectivity

GPS (internal): Optional internal or external GPS receiver

HD6-Series Mobile DVR

Inputs/Outputs

USB ports: Two front panel USB ports for mouse and video backup, firmware update, configuration, and debugging (log files, etc.)

WAN Ports: Rear panel WAN (Ethernet) port for connection to external 3G/4G cellular router and for connection to REI and non-REI in-vehicle systems

LAN Ports (IPC, etc.): Front panel LAN port for local DVR configuration, camera adjustment, IP camera setup, etc.

Front Panel Audio/Video Port: Front panel composite audio/video outputs for local DVR configuration, camera setup, etc. using a USB mouse

Vehicle Interface (J1939): Dual SAE J1939 250kbps/500kbps interface for connection to in-vehicle networks, multiplex systems, etc.

Accessory Port (RS485): For connection to optional REI peripherals, including accelerometer, output modules, display modules, RFID, etc., and non-REI devices

GPS/Status Port (RS232): Optional external (RS232) GPS receiver Optional GPS/Status output (RS232) for interface to third-party AVL systems

Sensor Inputs: Eight sensor inputs for detection of vehicle signals (brakes, turn signals, etc.)

HD6-Series Mobile DVR

System Overview

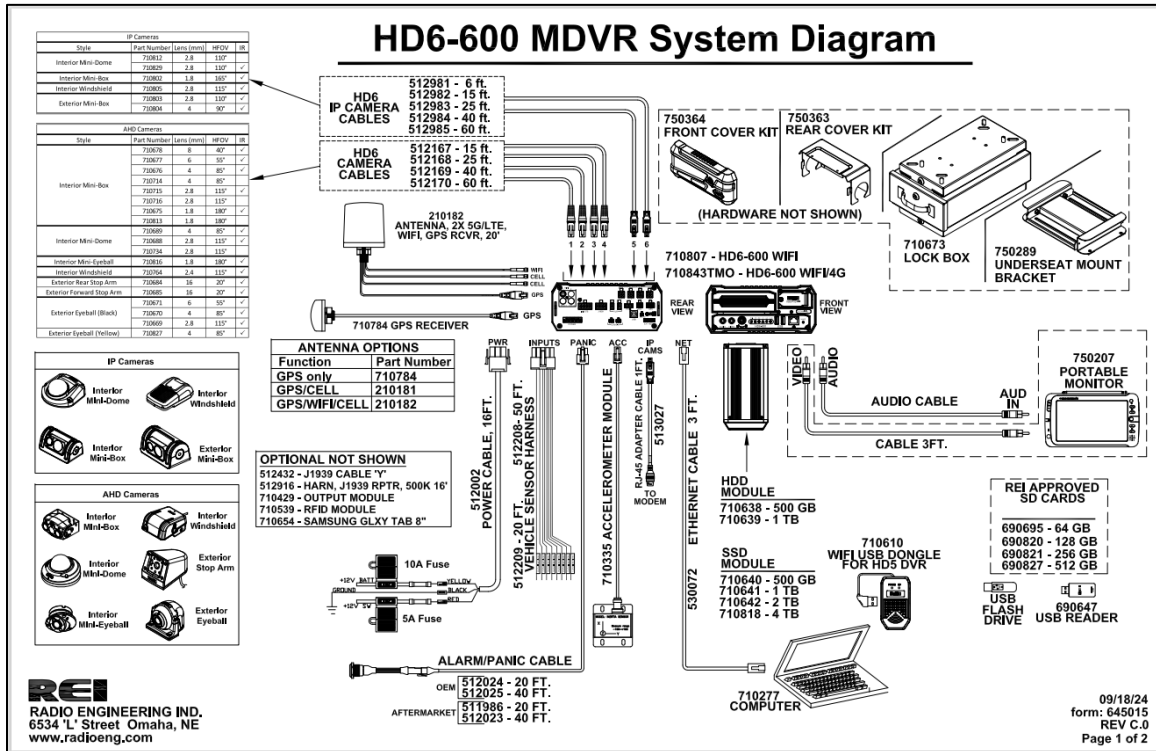

Figure 1: HD6-600-Series MDVR System Diagram

HD6-Series Mobile DVR

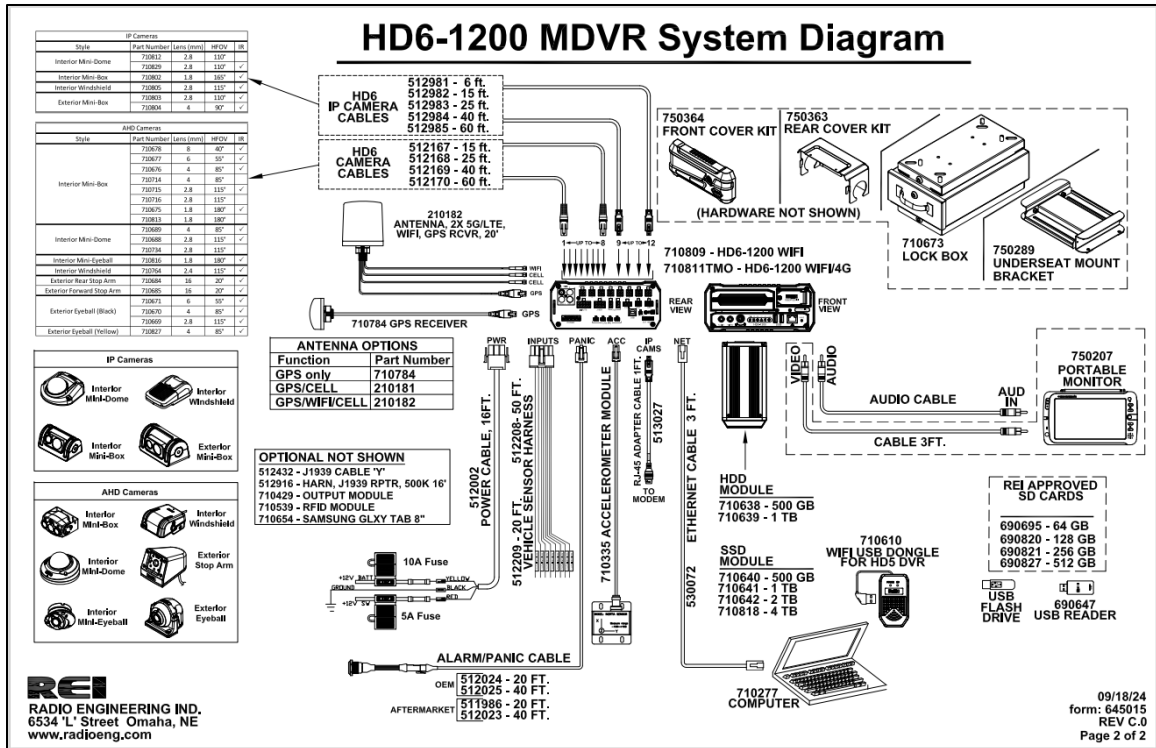

Figure 2: HD6-1200-Series MDVR System Diagram

HD6-Series Mobile DVR

Front and Back Panels

FRONT PANEL LAYOUT

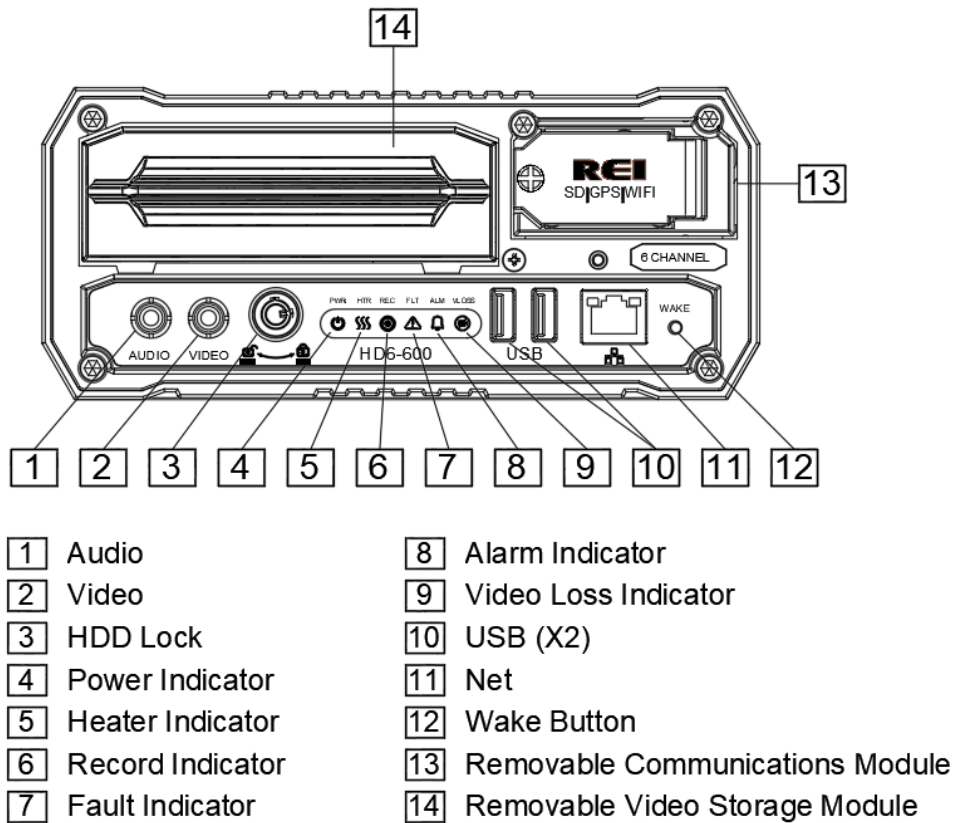

Figure 3: Front Panel Layout (HD6-600 Shown)

HD6-Series Mobile DVR

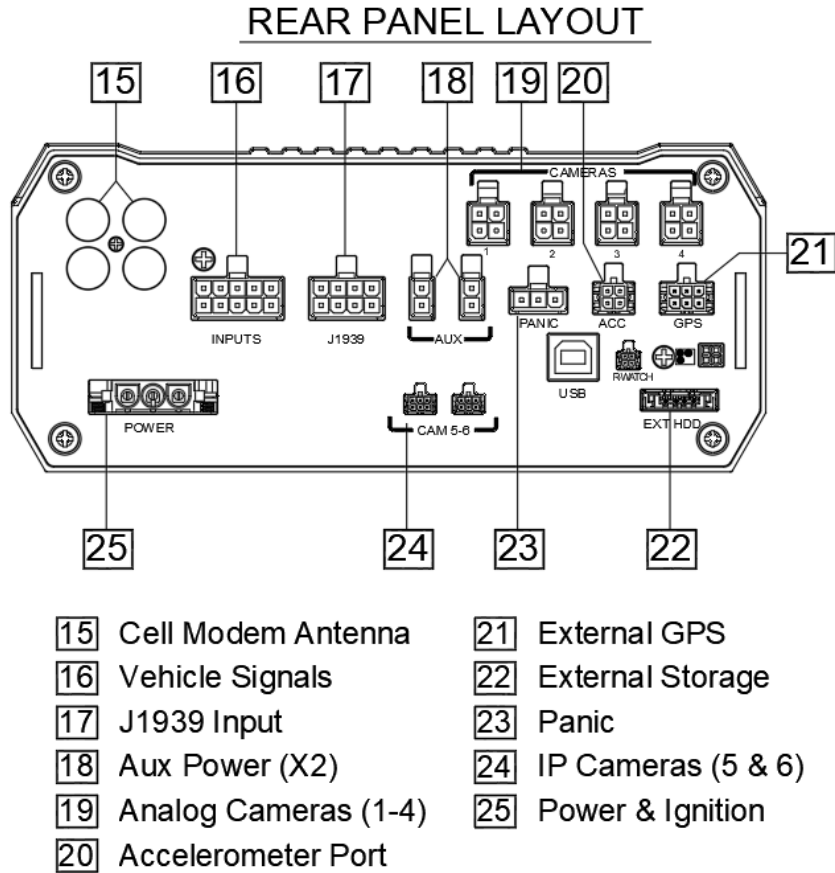

Figure 4: Rear Panel Layout (HD6-600)

HD6-Series Mobile DVR

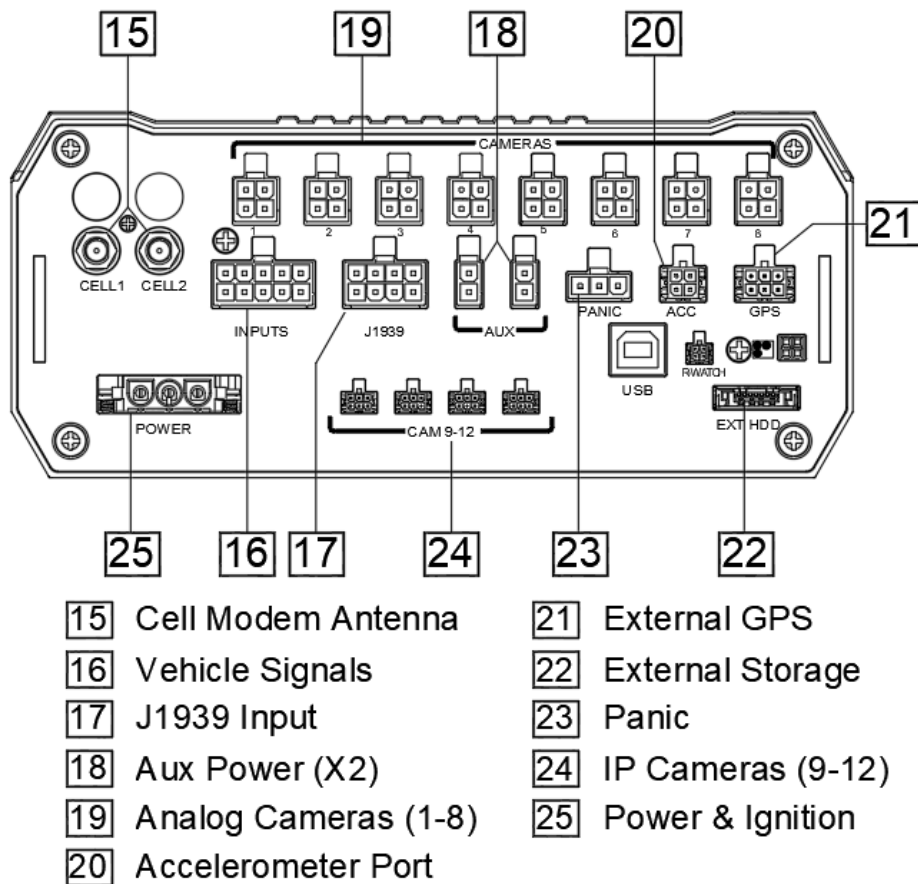

Figure 5: Rear Panel Layout (HD6-1200)

Live View

The default view in live view mode using a video monitor connected to the front of the 6-channel DVRs displays all channels in matrix view. Left clicking a USB mouse while in matrix view displays the video from that window into full screen. Left-clicking the mouse returns the display to matrix view.

Initial Set Up

The HD6-Series Mobile DVR system will operate prior to any user setup with the default settings. However, it may not show the correct time and date (factory set to Central Standard Time). To set the correct date and time, and program the system operation to your requirements, refer to the *Menu Configuration* section of this manual.

When accessing the menu, it is necessary to connect a video monitor to the video jack on the front or back of the unit. REI recommends using its battery-powered color LCD monitor P/N 750207.

HD6-Series Mobile DVR

Removable HDD and SD Card

DVR Loading and Unloading

Inserting HDD: Turn the HDD key to the unlocked and off position. Slide the HDD into the DVR and press firmly to make sure it is all the way in. Turn the HDD key to the locked and on position.

Removing HDD: Turn the HDD key to the unlocked and off position. Grab the handle on the HDD and carefully pull it out.

Note: The HD6-Series Mobile DVR will function even in the absence of an HDD. Without HDD, DVR will power on and allow the user to configure the settings, but it will not record any videos unless the user loads the HDD and locks the HDD key.

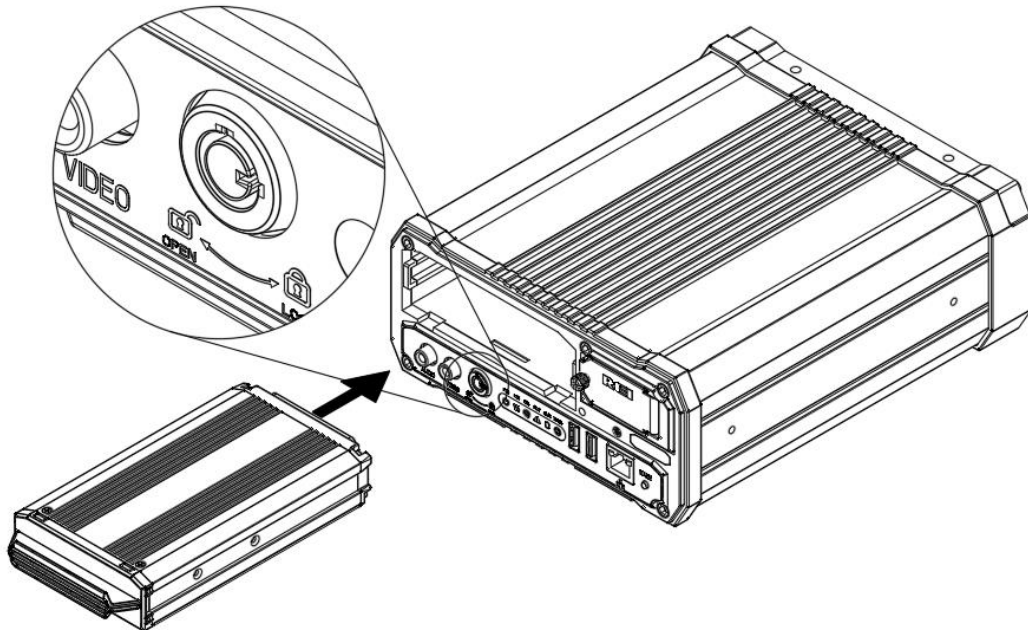

Figure 6: Removable Hard Drive Module

HD6-Series Mobile DVR

SD Card Loading and Unloading

Inserting SD Card: Open the access door and insert the SD card all the way in until it locks in place.

Removing SD Card: Push on the SD card all the way in, then release to eject the SD card.

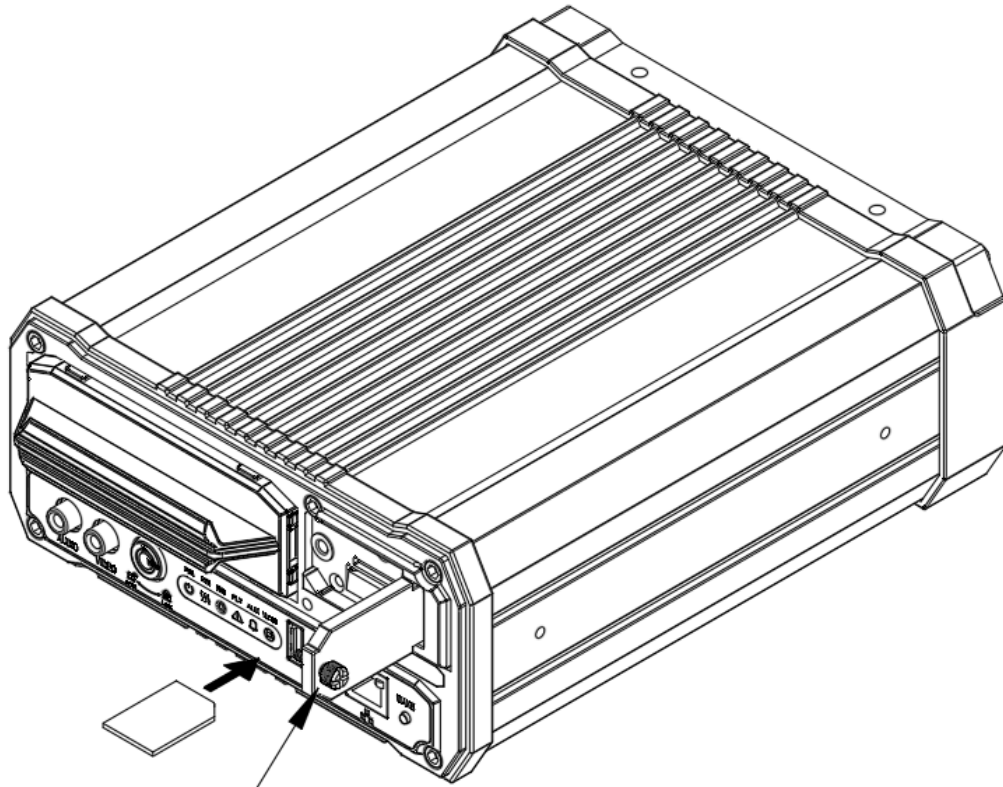

Unscrew knob to open door to
access SD card slot

Figure 7: Removable SD Card

HD6-Series Mobile DVR

HDD Record Times

To help estimate record times please visit our website www.radioeng.info/rte/HD6.zip.

Platform:	HDD Capacity:	Configuration:
HD5-1200	320 GB	Custom

Enable	Resolution	Frame Rate	Quality
<input checked="" type="checkbox"/> Analog Camera 1	720P	30 fps	100%
<input checked="" type="checkbox"/> Analog Camera 2	720P	30 fps	100%
<input checked="" type="checkbox"/> Analog Camera 3	720P	30 fps	100%
<input checked="" type="checkbox"/> Analog Camera 4	720P	30 fps	100%
<input checked="" type="checkbox"/> Analog Camera 5	720P	30 fps	100%
<input checked="" type="checkbox"/> Analog Camera 6	720P	30 fps	100%
<input checked="" type="checkbox"/> Analog Camera 7	720P	30 fps	100%
<input checked="" type="checkbox"/> Analog Camera 8	720P	30 fps	100%
<input checked="" type="checkbox"/> IP Camera 1	1080P	30 fps	100%
<input checked="" type="checkbox"/> IP Camera 2	1080P	30 fps	100%
<input checked="" type="checkbox"/> IP Camera 3	1080P	30 fps	100%
<input checked="" type="checkbox"/> IP Camera 4	1080P	30 fps	100%
<input checked="" type="checkbox"/> Sub-Stream	CIF	30 fps	100%

Main Stream	Sub-Stream	Resource Utilization
8 Hours	11 Hours	Analog: 100%
		IP: 100%

Figure 8: Estimator for HDD Record Times (HD5 shown)

HD6-Series Mobile DVR

Long Term Storage

The HD6-Series Mobile DVR system draws a small amount of current in stand-by mode. If the systems are installed, but not used for an extended length of time (i.e., longer than two weeks) it is recommended that the power be disconnected from the DVR to avoid draining the vehicle battery. The DVR internal clock will hold the time and date for up to 10 years sitting on a shelf. The daylight-saving time functions will resume upon re-initialization when power is applied.

HD6-Series Mobile DVR

Installation

WARNING

***DISCONNECT VEHICLE BATTERY VOLTAGE BEFORE INSTALLING
System WIRING***

WARNING

***DISCONNECT POWER TO THE DVR BEFORE JUMP STARTING
VEHICLE***

System Wiring

Numerous camera configurations:
See REI surveillance catalog for details.
DVR may support up to 6 cameras.

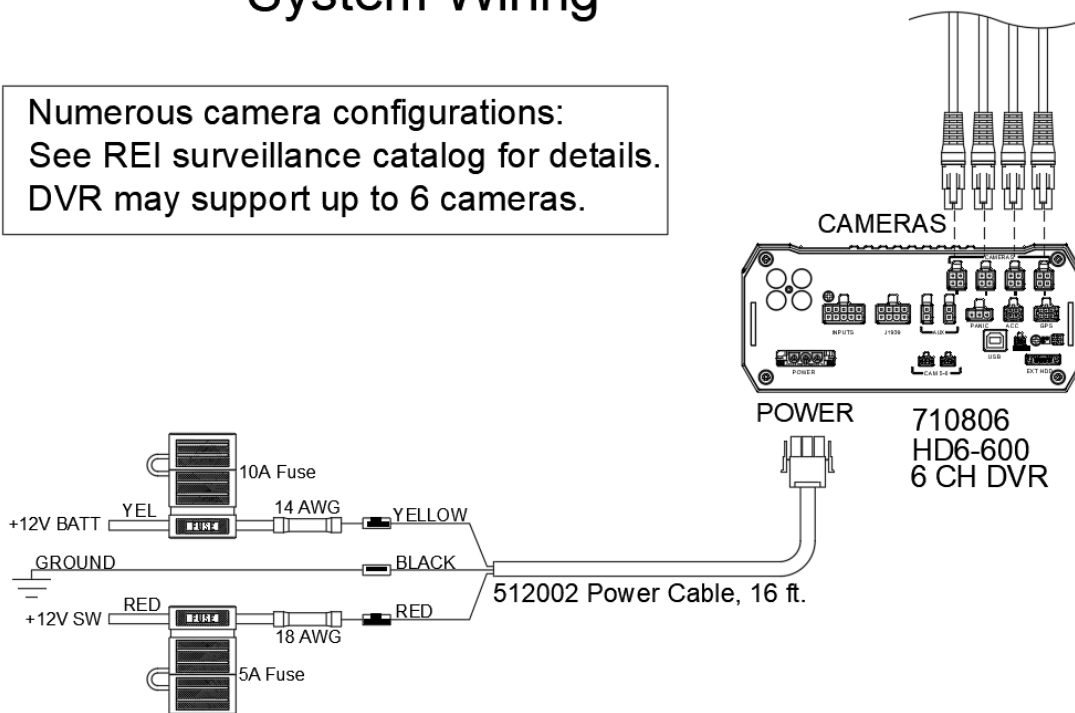

Figure 9: System Wiring - Power and Camera Cables (HD6-600)

HD6-Series Mobile DVR

System Wiring

Numerous camera configurations:
See REI surveillance catalog for details.
DVR may support up to 12 cameras.

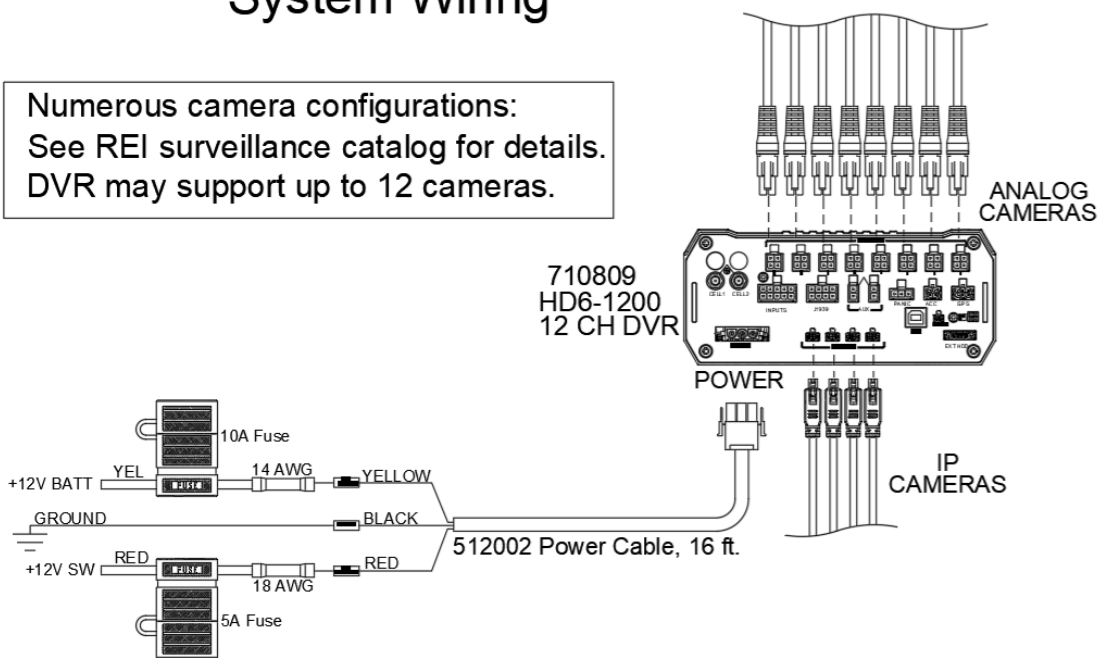

Figure 10: System Wiring - Power and Camera Cables (HD6-1200)

HD6-Series Mobile DVR

External Record Indicator / Event Mark Button Harness

External Record Indicator/Event Mark Button Harness

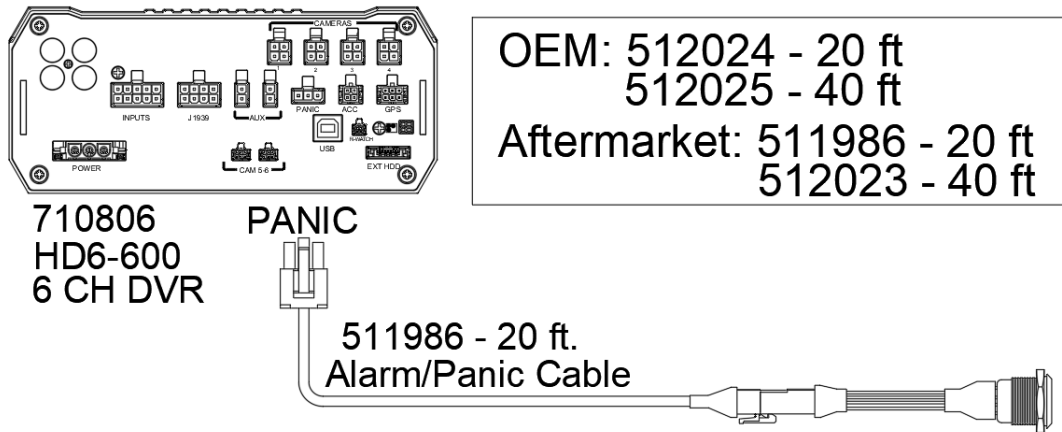

Figure 11: External Record Indicator/Event Mark Button Harness Connection

The optional external record indicator / event mark button harnesses (Panic Button) are available with two different types of switches, OEM, and aftermarket. The OEM switch is rectangular and fits into a standard size dashboard knockout. The aftermarket switch is round, for easier installation in vehicles without spare switch knockouts. Both styles of switches plug into the same port on the back of the DVR.

HD6-Series Mobile DVR

GPS Antenna Module Harness

GPS Antenna Module Harness

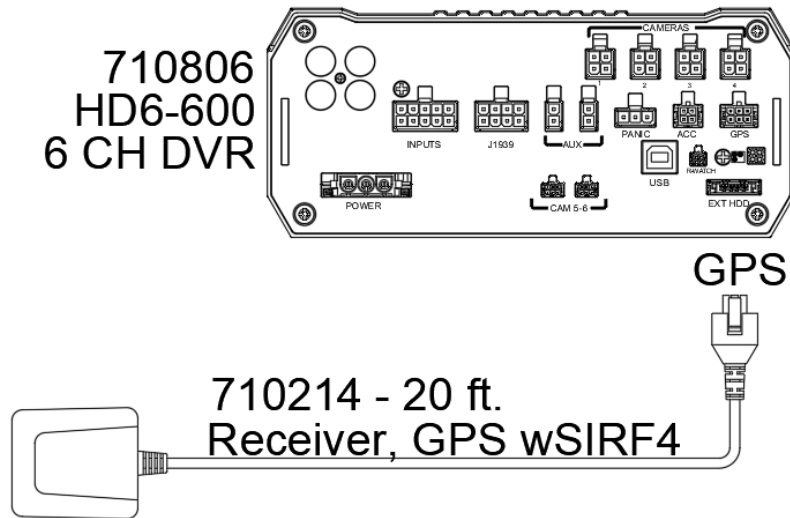

Figure 12: GPS Antenna Module Harness Connection

The optional DVR GPS antenna module harness plugs into the back of the DVR. This module will track up to 12 satellites at a time while providing one-second navigation updates at low power consumption.

The GPS antenna module is housed in a black, water-resistant case and designed to withstand rugged operating conditions. Information provided to the DVR system includes longitude, latitude, speed, heading, date, and time. Internal memory backup allows the GPS antenna module to retain critical data such as satellite orbital parameters, last position, date, and time to reduce valid data acquisition time.

The 710214 GPS antenna is used for extremely accurate requirements, if the DVR is used with a lot-based Wi-Fi network, it could be more cost effective to use the combination Wi-Fi/GPS antenna that comes with the higher end DVRs.

HD6-Series Mobile DVR

Vehicle Sensor Options Harness Vehicle Connections

(Shown as School Bus)

WIRE COLOR	WIRE DESCRIPTION
BLACK	RED WARNING LAMP
BROWN	YELLOW WARNING LAMP
RED	LEFT TURN SIGNAL
ORANGE	RIGHT TURN SIGNAL
YELLOW	STOP ARM
GREEN	BRAKES
BLUE	FRONT DOOR
VIOLET	REAR DOOR

Yellow Warning Lamps

Connect the BROWN wire to the Yellow lamp output of the Warning Lamp Flasher.

Red Warning Lamps

Connect the BLACK wire to the Red lamp output of the Warning Lamp Flasher.

Stop Arm Lamps

Connect the YELLOW wire to the switched side of the stop arm lamp.

Brake Lamp

Connect the GREEN wire to the switched side of one brake lamp.

Turn Signals

Connect the RED and ORANGE wires to the left and right turn signal lamps.

Front and Back Doors

Connect the BLUE and VIOLET wires to the switched side of the door switches.

HD6-Series Mobile DVR

On-Screen Information with Vehicle Sensor Options Harness

The HD6-Series Mobile DVR Surveillance system, when equipped with the HD6-Series Mobile DVR Option Harness, will display information on-screen in the Installers Mode when the monitored switches on the vehicle are activated and signals are applied to the monitored sensors.

ACTIVE SWITCH OR SIGNAL	ON-SCREEN DISPLAY
BRAKE APPLIED	BR
STOP ARM DEPLOYED	SA
YELLOW WARNING LAMPS On	YW
RED WARNING LAMPS On	RW
LEFT TURN SIGNAL On	LT
RIGHT TURN SIGNAL On	RT
FRONT DOOR OPEN	FD
REAR DOOR OPEN	RD
SPEEDOMETER (SEE NOTE 1)	XX MPH

NOTE 1:

The XXs represent the vehicle speed (i.e., 35).

HD6-Series Mobile DVR

Accelerometer Module Harness

Accelerometer Module Harness

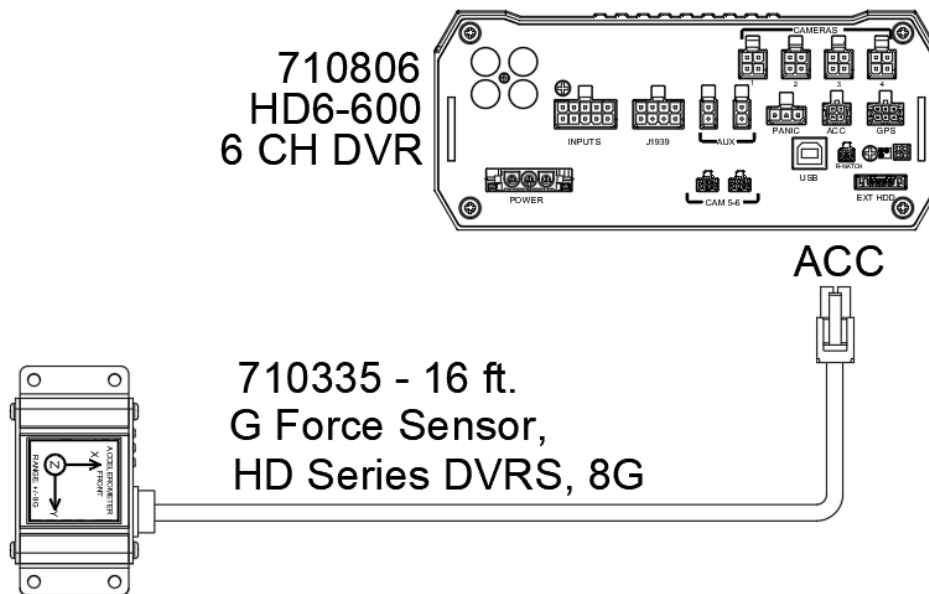

Figure 14: Accelerometer Module Harness Connection

The optional external Accelerometer, or Inertia Sensor, must be hard mounted to the vehicle floor, frame, or some other non-dampened part of the vehicle. If external dampening is used for the DVR, hard mounting the accelerometer will prevent the accelerometer readings from being compromised.

To properly install the Accelerometer Module, the user must align the device with the picture on top of the module. The 'X' axis is drawn from the back to the front of the bus, the 'Y' axis is drawn from the side of the bus to the other side of the bus, and the 'Z' axis is drawn from the bottom to the top of the bus. After the device has been properly aligned, the Accelerometer Module must be calibrated.

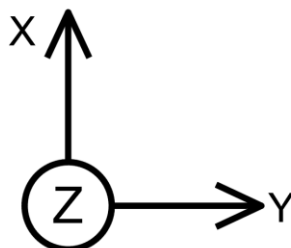

Figure 15: 3 Axis Inertia Sensor Directions

HD6-Series Mobile DVR

Physical Mounting Requirements

L Bracket Mounting

The DVR has two L-brackets along the side of the unit to allow easy mounting. This type of installation is recommended for vehicles that have a secured compartment, such as a radio box, where the DVR is protected from tampering.

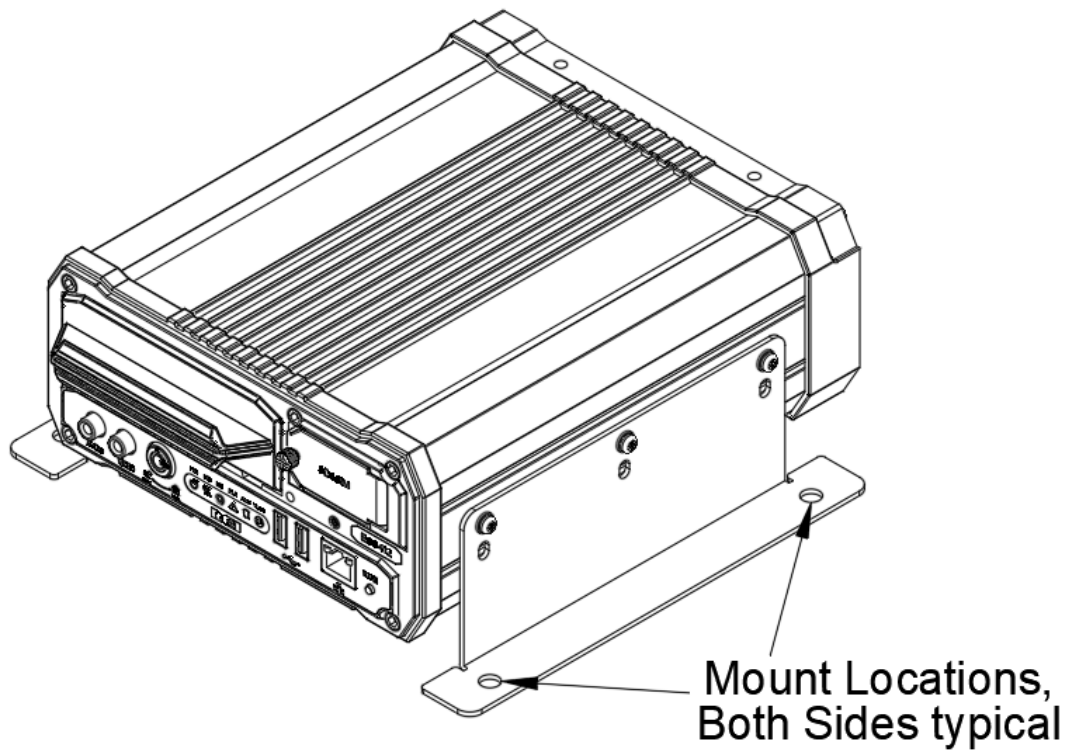

Figure 16: L Bracket Mounting

HD6-Series Mobile DVR

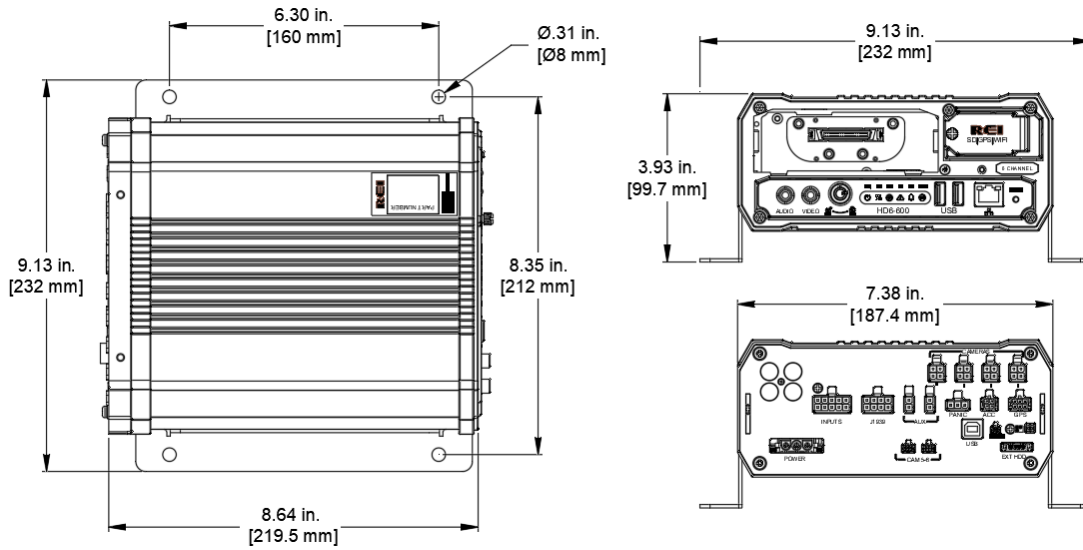

Figure 17: DVR Dimensions

Security Cover Mounting

There may be installations that require the front and back of the DVR to be enclosed in a protective enclosure. Security covers can be installed to protect the front and back of the DVR.

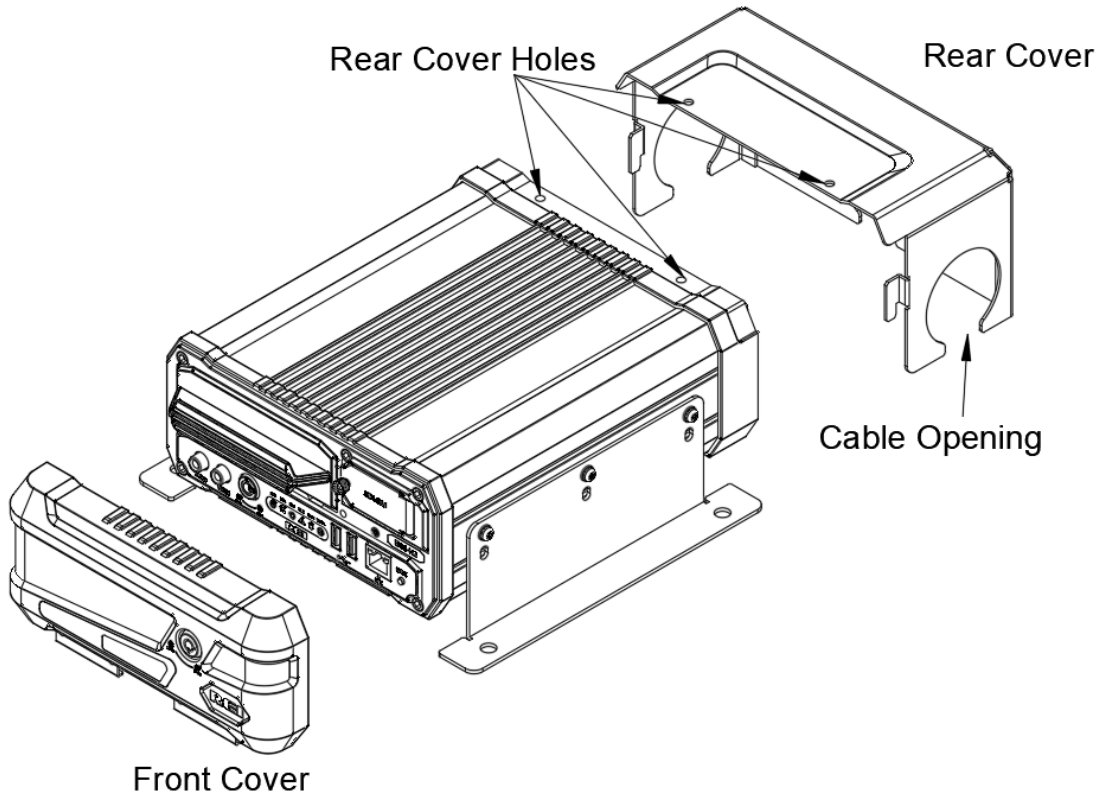

Figure 18: Security Cover Mounting

HD6-Series Mobile DVR

IMPORTANT:

Check local, state, and federal guidelines as to modification of the existing structures within the vehicle.

Camera Placement

The HD6-Series Mobile DVR cameras can be mounted anywhere in the vehicle, unless the mount is unstable, or the cameras vibrate excessively. Use outdoor cameras for exterior placement.

System Start-Up

To start the recording process, start the vehicle. Upon turning the system switch ON, the HD6-Series Mobile DVR will commence recording.

System Shut Down

To stop the recording process off the vehicle: If the OFF-DELAY option is enabled, the HD6-Series Mobile DVR will continue to record for the prescribed number of minutes. When the off-delay expires, the camera and HD6-Series Mobile DVR shut off. If a download delay is used, the DVR will stay active after any off delay expires for network access to the hard drive but will not record any new video in this mode.

HD6-Series Mobile DVR

Playback Options

The various ways to view recorded videos: through the TV Video Outputs, through the Removable Hard Drive Module, SD card, through the PC Network Connection, and with a mobile device such as a cell phone or a tablet.

TV Video Outputs

Using a TV Monitor and a USB mouse, the user can access recorded video files by Date and Time or by Event. After selecting the appropriate file, the user can review the video using Play, Stop, Pause, Fast Forward, Fast Rewind, Slow Forward, Slow Rewind, Frame Forward, and Frame Reverse.

Removable HDD and SD Card

Using the REI VMS PC Software, the user can access the files by connecting HDD or SD Card to the computer.

PC Network Connection

Using the REI VMS PC Software, the user can access the files by connecting the computer to the DVR Front Panel Ethernet port, as shown below.

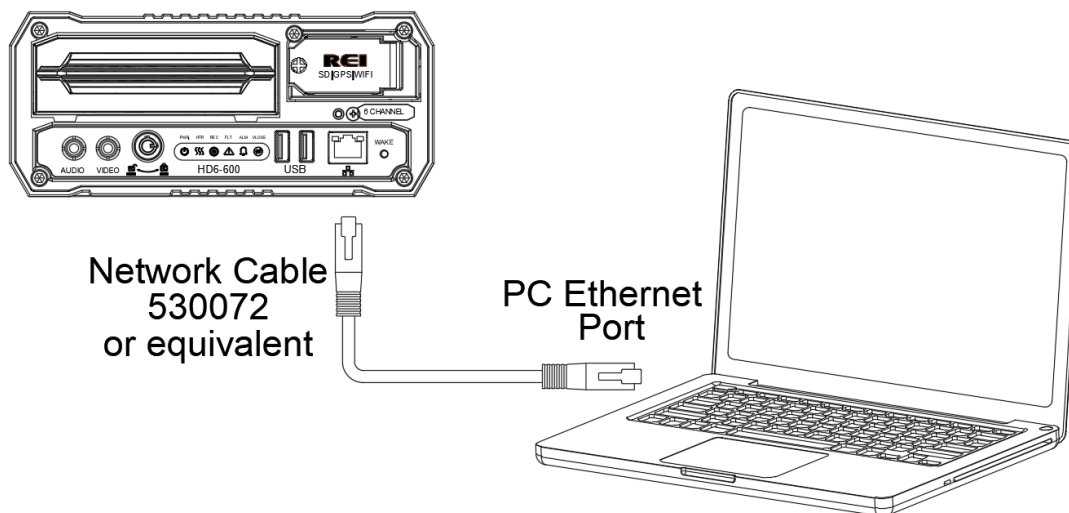

Figure 19: Connecting to the DVR with a Computer through the Ethernet Connection

HD6-Series Mobile DVR

Default DVR LAN Settings:

IP Address: 192.168.200.200

Net Mask: 255.255.255.0

Password: 10231981

To access the DVR from a computer, the TCP/IP network settings on the computer need to be configured to match the settings in the DVR to insure both devices are in the same network. For example, when DVR network is set to default as above, the TCP/IP on the computer needs to be set as follows:

IP Address: 192.168.200.x (x being 1-255 but different from DVR IP address)

Net Mask: 255.255.255.0 (DVR Net Mask)

Gateway: 192.168.200.254 (DVR Gateway) - optional

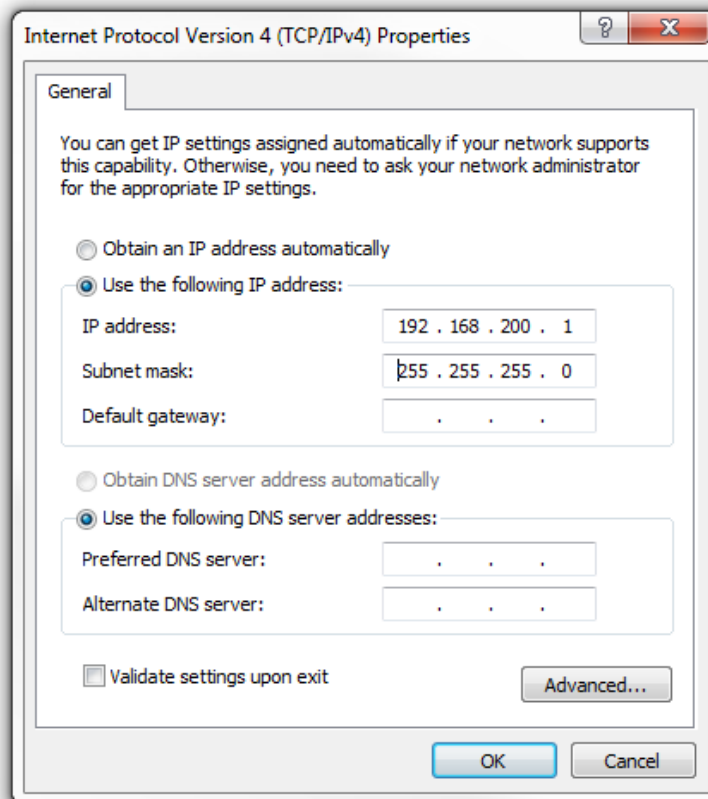

HD6-Series Mobile DVR

Once the computer is set up, open Internet Explorer and enter the IP address of the DVR in the web address bar. In some cases, the web browser may display a prompt requesting the installation of add-on software in order to access the DVR Web UI. Before displaying the Web UI, the web browser will display a prompt requesting the username and password for the DVR. After entering the username and password, the web browser will open the Web UI. Refer to the Web UI section for more information.

REI Toolkit

The use of a REI Toolkit Dongle enables a wireless connection from the DVR to a hand-held device (iPhone™, Android™, or touch pad) in the event Wi-Fi is not available.

The REI DVR Toolkit must be downloaded on the hand-held device used in conjunction with the REI Toolkit Dongle and the DVR.

To download the REI DVR Toolkit, complete the following instructions:

If using an Android™ device:

- From the Google Play Store search for the REI DVR Toolkit by typing REI DVR Toolkit in the Search window in the Apps section and click the Search icon.
- Click on the REI DVR Toolkit icon  to open the app
- Click the Install button

If using an Apple device (iPhone™):

- Enter REI DVR Toolkit in the search window on the Apple application store and click search
- Click Get
- Click Install
- Sign In with your Apple ID and follow the installation prompts

REI Toolkit Dongle Connection

Before establishing connectivity with your Android™ or iPhone™, plug the USB cable from the REI Toolkit Dongle into the DVR.

When the REI Toolkit Dongle is connected to the DVR, a blue ‘Power’ lamp will illuminate to indicate the device is operating.

Note: If the REI Toolkit Dongle is unavailable it is possible, on Wi-Fi enabled HD6 series DVRs, it is possible to obtain a Wi-Fi connection by pressing and holding the Wake button for two seconds.

HD6-Series Mobile DVR

Connecting to an Android™



To connect to the REI Dongle, go into ‘Settings’ and choose ‘Network & Internet,’ and then ‘Wi-Fi.’

From the list of Wi-Fi links, locate the appropriate Wi-Fi  link and attempt to make a Wi-Fi connection. It is normal to see the message ‘Connected, no Internet’ indicating there is no Internet connection.

Close the application.

From the home screen of your Android™ device, select the REI DVR Toolkit icon  that will open the initial REI DVR window.

Connecting to an iPhone™

When using an iPhone™, make sure the device is plugged in the DVR (for example REI-009). To verify the Wi-Fi connection to the DVR is available on your iPhone™, select the Settings icon  and then select the Wi-Fi icon  to open the list of available Wi-Fi networks under ‘CHOOSE A NETWORK’. At this point, the connection for the example DVR, REI-009, should appear on the list of Wi-Fi networks. From the home screen of your iPhone™ select the REI DVR Toolkit icon  to open the REI DVR window. Once the REI DVR Toolkit has been opened, the initial REI DVR window will appear on the iPhone™ with the name of the DVR connection (the example REI-009 shown on the Initial DVR window). At this point, the REI DVR Toolkit is available for use.

Auto Local/Manual Remote

On the initial screen, **Auto Local** is selected by default. This setting means the DVR wireless hardware switched over to access point mode and is connecting locally on the bus. If set to **Manual Remote**, the access point is based on IP forwarding to connect to lot-based Wi-Fi to enable a connection to any of the active buses remotely without having to be aboard the bus.

HD6-Series Mobile DVR

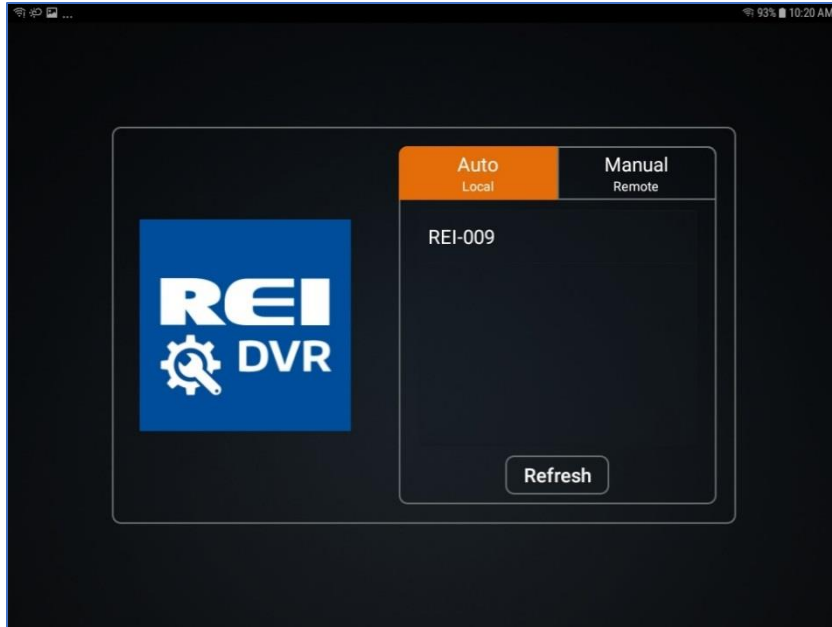

Figure 20: Initial DVR Window

Logging In

Touch the name of the DVR, (REI-009 for example) and a Login prompt will appear as shown below.

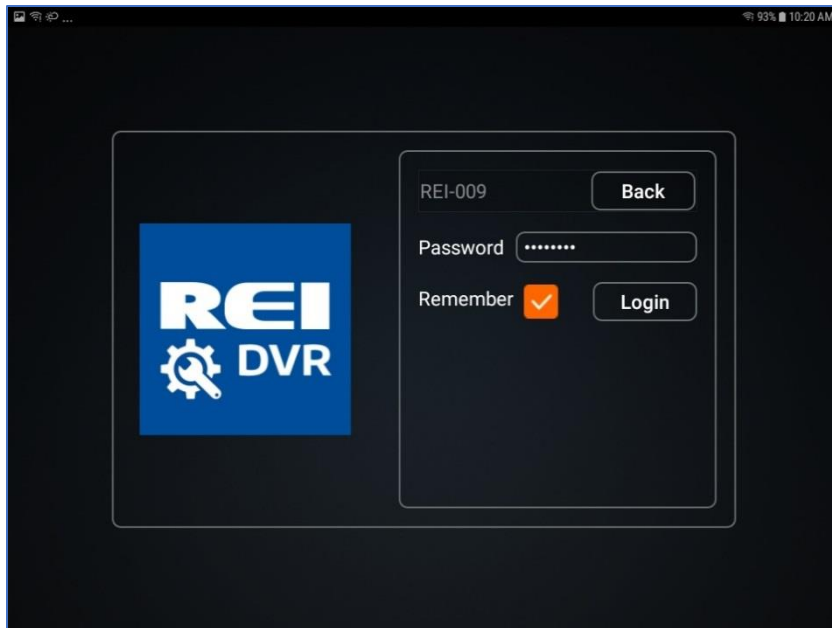

Figure 21: Login Window

By default, the initial password is 10231981. The **Remember** box could already be checked. If not, enter the password and click **Login**. The initial window will appear where the user can begin to access the REI ARMOR DVR firmware.

HD6-Series Mobile DVR



SD Card Function

On the side of the REI Toolkit Dongle is a slot that serves as a Secure Digital (SD) card reader.

When the red SD lamp is active, it indicates the SD card has been successfully loaded in the SD card slot and is operational.

The primary purpose of using the SD card function is to make system upgrades. A system upgrade is made by downloading the upgraded content from the SD card to the DVR. The card operates like a flash drive and the system-upgrade content from the SD card will be displayed on the hand-held device and the system upgrade steps can be performed.

Logging Out

When using an Android™ device, selecting  will open the **Logout** prompt and choosing 'Yes' will end the Wi-Fi connection. Selecting  will also allow an exit from Live View.

When using an iPhone™, selecting  will allow an exit from Live View. To logout using an iPhone™, press the **Home** button and disconnect the REI Toolkit Dongle from the DVR.

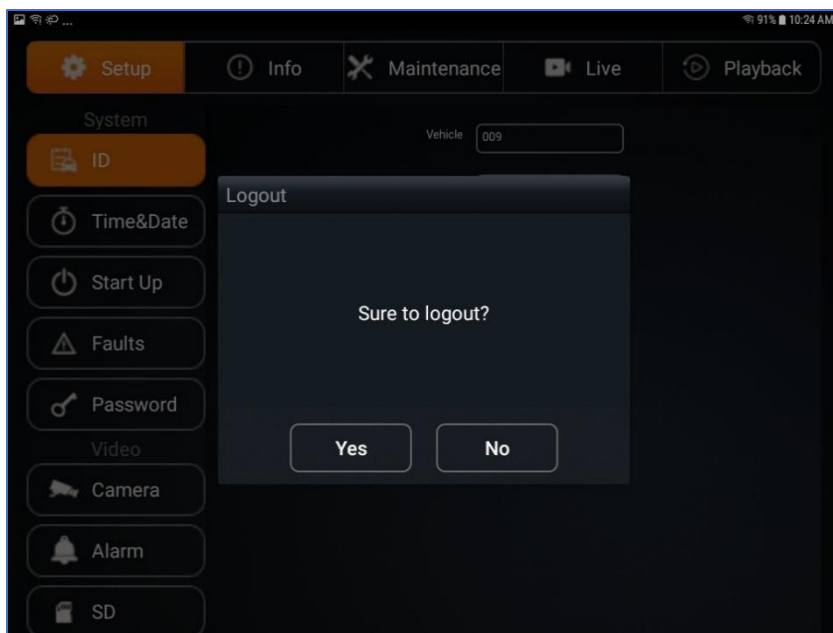

Figure 22: Logout Window

For more information about using the REI Toolkit, refer to the *REI Toolkit Quick Guide*.

Menu Configuration

Main Menu Page

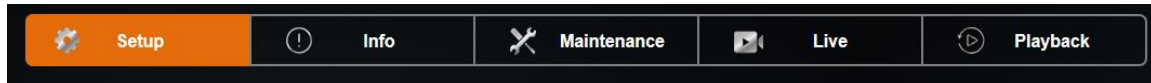

Figure 23: Main Menu

The DVR Main Menu can be accessed by using any standard USB mouse and video monitor. For more convenient usage, REI offers its hand-held USB trackball mouse; P/N 690816. The user can access recorded videos and customize the settings on the DVR.

The Main Menu is comprised of five user tabs: Setup, Info, Maintenance, Live, and Playback.

Setup Menu

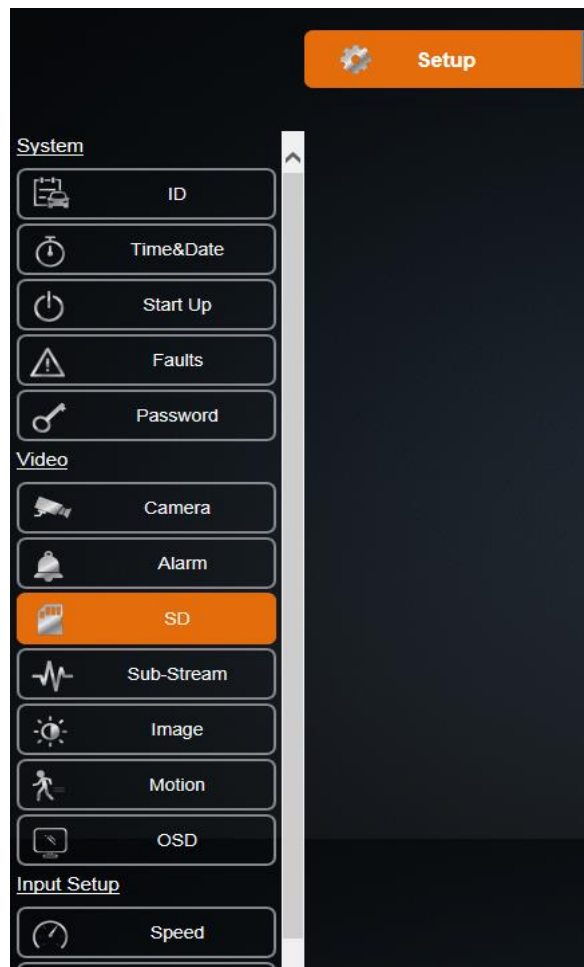

Figure 24: Setup Menu

HD6-Series Mobile DVR

The Setup section of the Menu is subdivided into four main categories listed in the left column of the window: System, Video, Input Setup, and Network.

System Setup Menu



Figure 25: System Setup Options

System: The System section of the Setup Sub-Menu is sub-divided into five subcategories: ID, Time & Date, Start Up, Faults and Password. The user can give the vehicle a name, set the time and date, set when the DVR starts recording, set fault indicators, fault beepers, external record indicator, stand-by mode display, and set a password for the DVR.

ID Menu

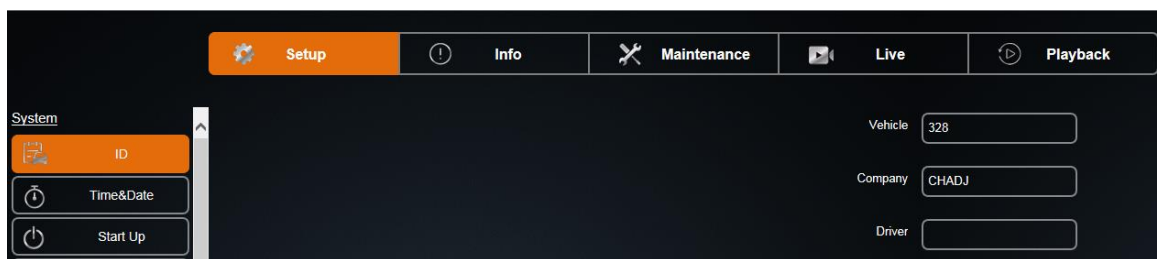

Figure 26: ID Menu

ID Menu allows the user to enter the Vehicle, Company, and Driver name.

Vehicle: Allows custom information to identify the DVRs, such as bus number.

Company: Allows the user to enter company name of the bus service.

Driver: Allows user to enter a driver's name.

HD6-Series Mobile DVR

Time & Date Menu

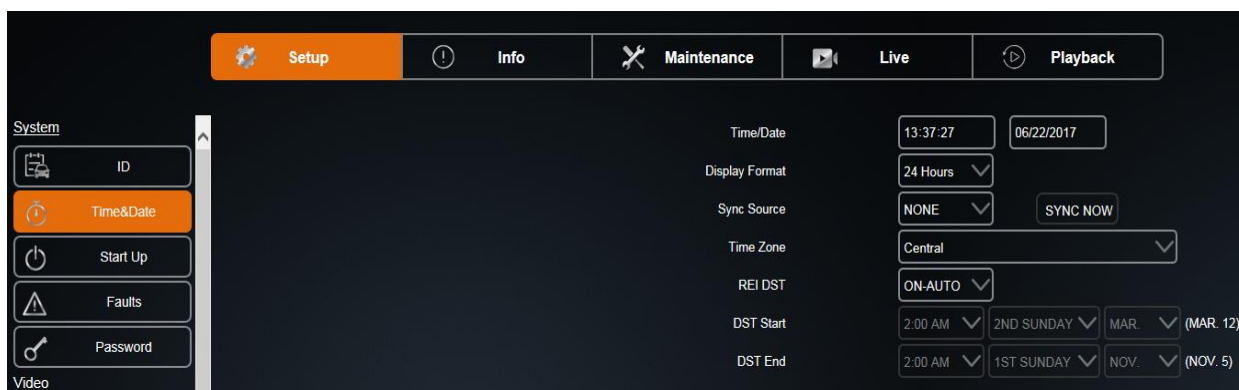

Figure 27: Time & Date

Time & Date menu allows the user to configure options for setting the Date and the Time. All REI DVRs have high accuracy, extended temperature range real time clocks with 10-year internal battery backup for consistent and reliable time keeping over the life of the DVR system.

Time/Date: Displays the current date and time, allowing the user to change the date and time.

Display Format: Allows the user to select between 12-hour or 24-hour display format.

Sync Source: Allows the DVR to synchronize to a time synchronization service, either GPS (Global Positioning System), or NTP (Network Time Server), or None. When Time Sync Source is selected except 'None,' press the Sync Now button to synchronize the time immediately, or the DVR will synchronize time automatically at midnight.

Time Zone: Used with the GPS and Sync Time, as GPS satellite time comes in as GMT and will need to be offset for your time zone for proper automatic time synchronization.

REI DST: When set to On-Auto, will make the system clock change automatically with Daylight Saving Time. In regions where Daylight Saving Time is not observed, setting this item to OFF disables the Daylight-Saving Time function.

Engineering Rewrite: DST Start/DST End: The Day Light Saving Time Mode can be set to 'On-Auto', 'OFF, or to 'On-Manual'. When the DST Mode is set to 'On-Auto', the Daylight-Saving Time triggers will conform to the existing US 2005 rules. When the DST Mode is set to 'On-Manual', the Daylight-Saving Time triggers can be changed to any of the first, second, third, fourth, or last week of any month, not overlapping.

HD6-Series Mobile DVR

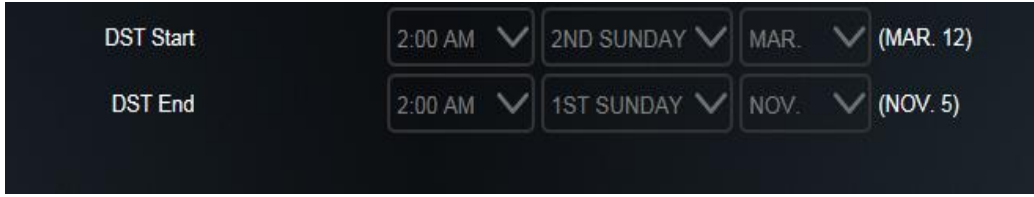

DST Start	2:00 AM	2ND SUNDAY	MAR.	(MAR. 12)
DST End	2:00 AM	1ST SUNDAY	NOV.	(NOV. 5)

Figure 28: Custom DST Triggers

Start Up Menu

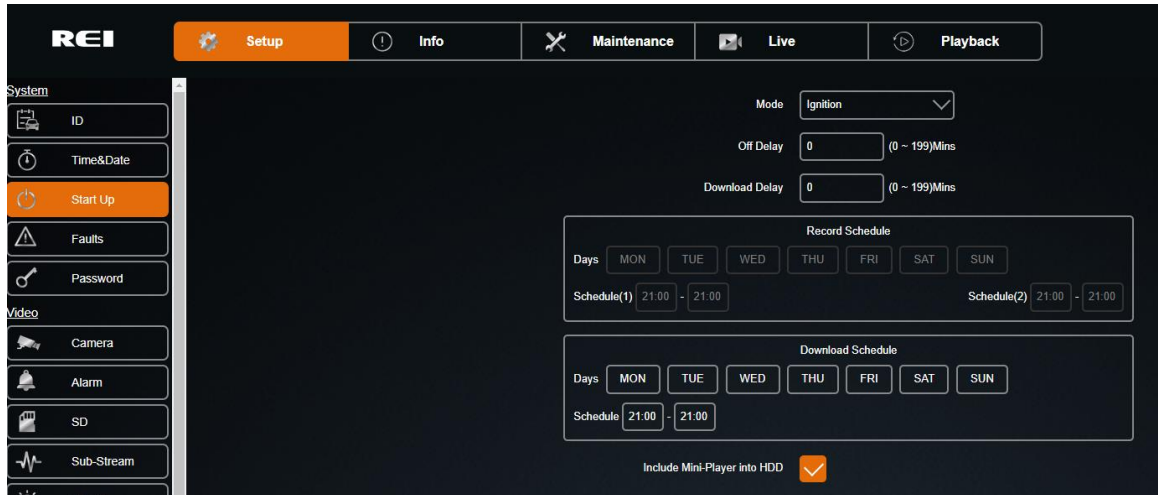

REI Setup Info Maintenance Live Playback

System

- ID
- Time&Date
- Start Up
- Faults
- Password

Video

- Camera
- Alarm
- SD
- Sub-Stream

Mode: Ignition

Off Delay: 0 (0 ~ 199)Mins

Download Delay: 0 (0 ~ 199)Mins

Record Schedule

Days: MON TUE WED THU FRI SAT SUN

Schedule(1): 21:00 - 21:00 Schedule(2): 21:00 - 21:00

Download Schedule

Days: MON TUE WED THU FRI SAT SUN

Schedule: 21:00 - 21:00

Include Mini-Player into HDD

Figure 29: Start Up Menu in Ignition Mode

The Start Up Menu allows the user to determine when the DVR starts/stops recording video and how long the DVR stays on after shutting off the ignition.

Mode: Select from the following three Mode settings; Ignition, Schedule, Either Ignition or Schedule.

Ignition: DVR starts recording for as long as the ignition signal stays on.

Schedule: DVR starts recording only by schedule regardless of ignition signal.

Either Ignition or Schedule: DVR starts recording by schedule or when ignition is on at the same time.

Off Delay: The number of minutes the DVR records after the ignition is off. Ranges between 0-199 minutes.

Download Delay: The number of minutes the DVR stays on and not recording after the ignition is off and off delay has expired.

Record Schedule: The days and times the DVR will turn on and record automatically in any schedule mode.

Download Schedule: The days and times the DVR will turn on and not record to allow further downloading of video.

HD6-Series Mobile DVR

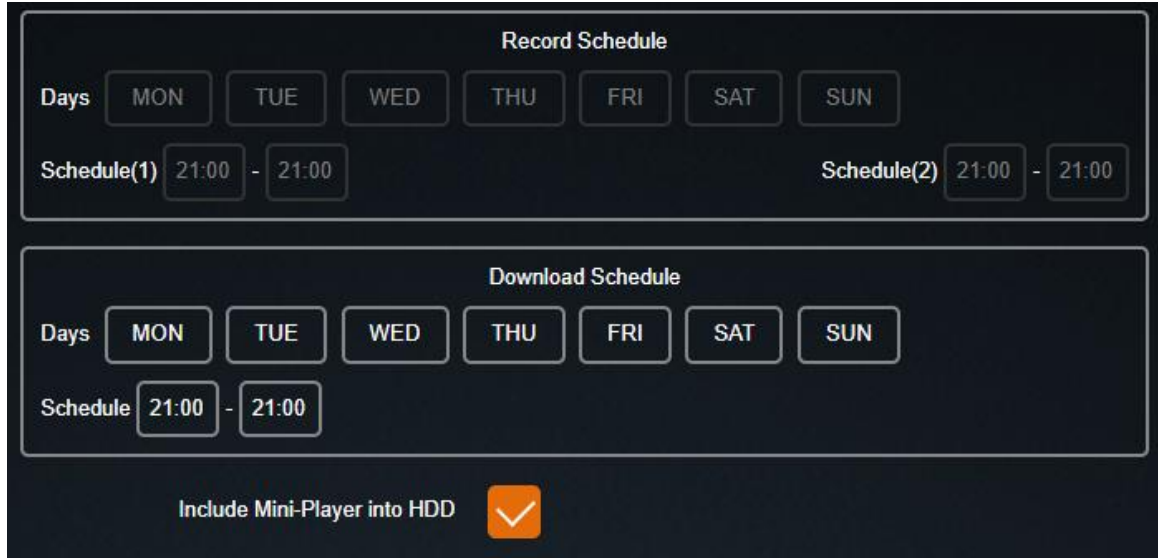

Figure 30: Record Schedule Menu

Include Mini-Player Into HDD: Check this box to enable the mini-player.

Faults Menu



Figure 31: Faults

The Audio/Visual Setup menu enables the DVR to display an Audio/Visual alert if the DVR is experiencing an alert condition.

Fault Indicator: The types of alerts/faults that will be displayed on Fault Indicator.

Blind Camera: Camera blocked by objects.

Video Loss: DVR not receiving camera video.

HDD Fault: DVR not able to record video onto HDD.

HD6-Series Mobile DVR

System Fault: DVR experiencing problems such as voltage too high or too low.

Fault Beeper: The types of alerts/faults that will cause the fault beeper to activate.

Blind Camera: Camera blocked by objects.

Video Loss: DVR not receiving camera video.

System Fault: DVR experiencing problems such as voltage too high or too low.

HDD Fault: DVR not able to record video onto HDD.

External Record Indicator: Display alarms or faults on the External Record Indicator.

Display Faults: Allows DVR to display faults.

Display Alarms: Allows DVR to display alarms.

Standby Mode Display: Display alarms or faults when the DVR is in standby mode.

Display Faults: Allows DVR to display faults in standby mode.

Display Alarms: Allows DVR to display alarms in standby mode.

Standby Period: Number of minutes to display alarms or faults in standby mode.

Password Menu

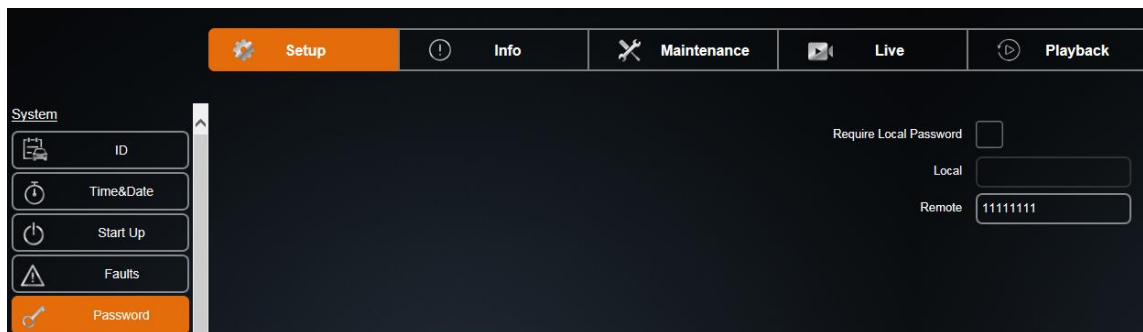

Figure 32: Password

Use the Password Menu to secure the DVR with a password.

Require Local Password: Set to 'On' by default. A password is not required when the setup menu is entered using a monitor and mouse.

Local: Password required when Require Local Password is set to 'On' and a password is entered in the Local text box.

Remote: Password required for access to the DVR-hosted configuration menu webpages.

Video Setup

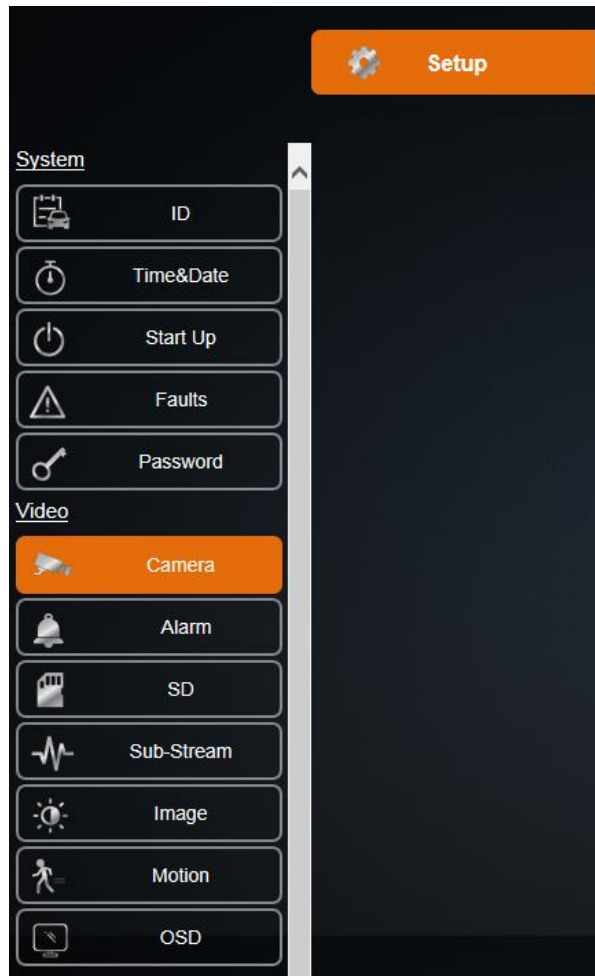

Figure 33: Video Setup

Video: The Video setup section of the menu is sub-divided into seven main categories; Camera, Alarm, SD, Sub-Stream, Image, Motion and OSD.

Under Video, the channels can be enabled or disabled, and the camera configuration can be set up. It is possible to set up the amount of time to record before and after alarms. Users can configure the system to record to SD card for alarms, configure the sub-stream settings, and change the settings for the image. Users can also set up motion detect and motion alarms and configure the OSD.

HD6-Series Mobile DVR

Camera Menu

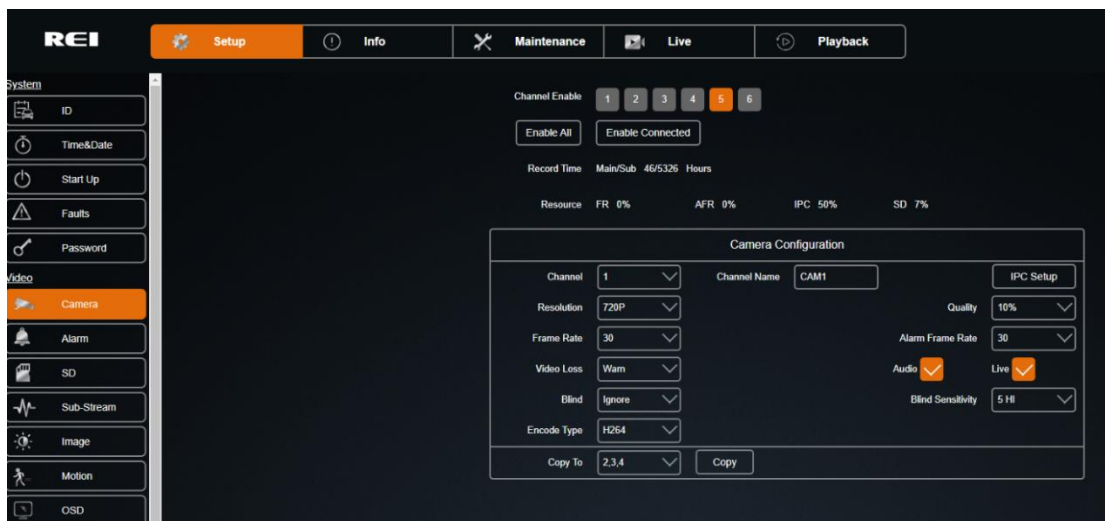

Figure 34: Camera – Camera Setup

The Camera Setup subsection of the Video Setup section allows the user to change all the related camera record settings, such as number of cameras, resolution, frame rate, etc.

Channel Enable: Custom camera record setting for each camera.

Enable All: Enable all channels.

Enable Connected: Enable channels with currently connected cameras.

Record Time: The amount of time the HDD can record under the current camera setup. Main Stream/Total Record Time.

Resource FR/AFR/IPC/SD: Non-alarm and Alarm Frame rate percentage at current camera setup.



Figure 35: Custom Record Settings

HD6-Series Mobile DVR

The Camera Configuration setting allows a customized record setting to each individual camera.

Channel: Enables channel to display on screen in the Channel Name cell when selected. Note: When Live is selected, but Rec is not selected the DVR only displays that camera video but does not record it.

Resolution: Record video resolution. (Camera dependent, up to 1080p)

Frame Rate: Video frame rate during non-alarm recording. Any number between 1 and 30 can be selected.

Video Loss: User can select one of three options: Ignore, Warn and Alarm.

Blind: User can choose between three options: Ignore, Warn, and Alarm.

IPC Setup: Click to open an IP setup menu to select IP camera types.

Quality: Video quality. The scale ranges from 100% being highest taking up more HDD space; to 10% being lowest taking up less HDD space.

Alarm Frame Rate: Video frame rate during alarm recording: can select any number between 1 and 30.

Audio: Record camera audio if selected.

Live: Displays live video.

Blind Sensitivity: User can choose between 1 – LO and up to 5 – HI.

Copy To: Select the cameras to copy the settings to and click Copy.

IP and Port Setup Menu

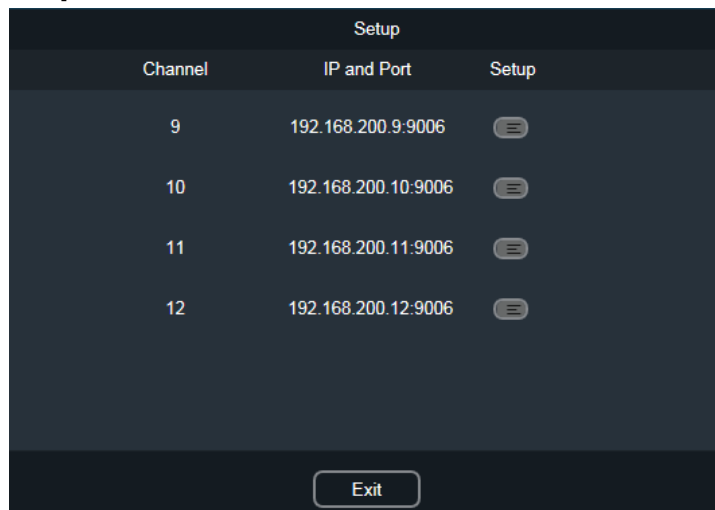

Figure 36: IPC Setup Pop-up Window

HD6-Series Mobile DVR

Network Setup Menu

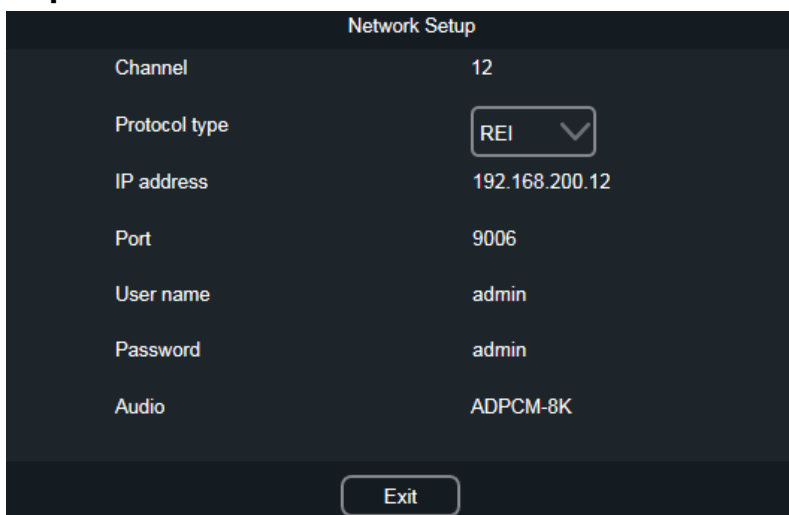

Figure 37: Individual Channel Network Setup

Channel: The number of the channel being setup

Protocol Type: REI

IP address: Internet protocol address of the channel being setup

Port: Port identification for the channel

User name: Used to enter camera configuration menu

Password: Used to enter camera configuration menu

Audio: Audio codec currently used

Click Exit after setup is complete.

For additional information about IP camera configuration, refer to the HD6 Series Models section of the REI Customer Support Site by clicking on the following link - <http://www.radioeng.info/>

Alarm Menu

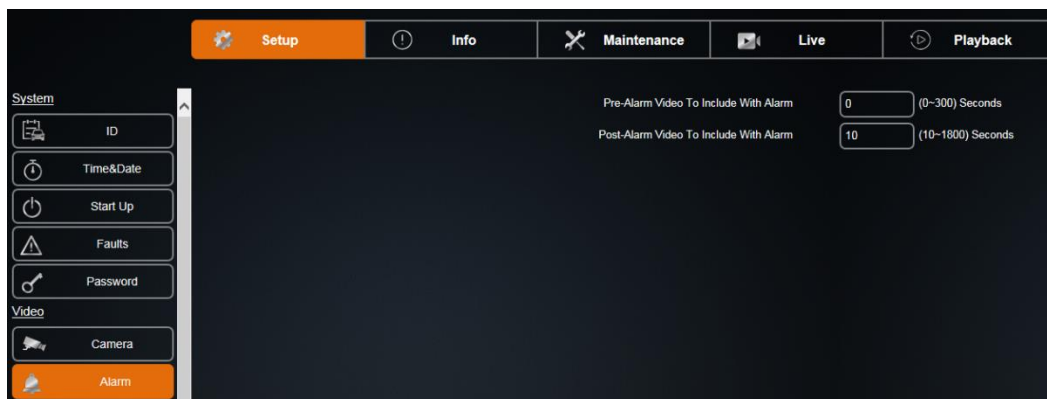

Figure 38: Alarm Setup

HD6-Series Mobile DVR

Pre-Alarm Video to include with Alarm: Range is set between 0-300 seconds.

Post-Alarm Video to Include with Alarm: Range is set between 10-1800 seconds.

SD Menu

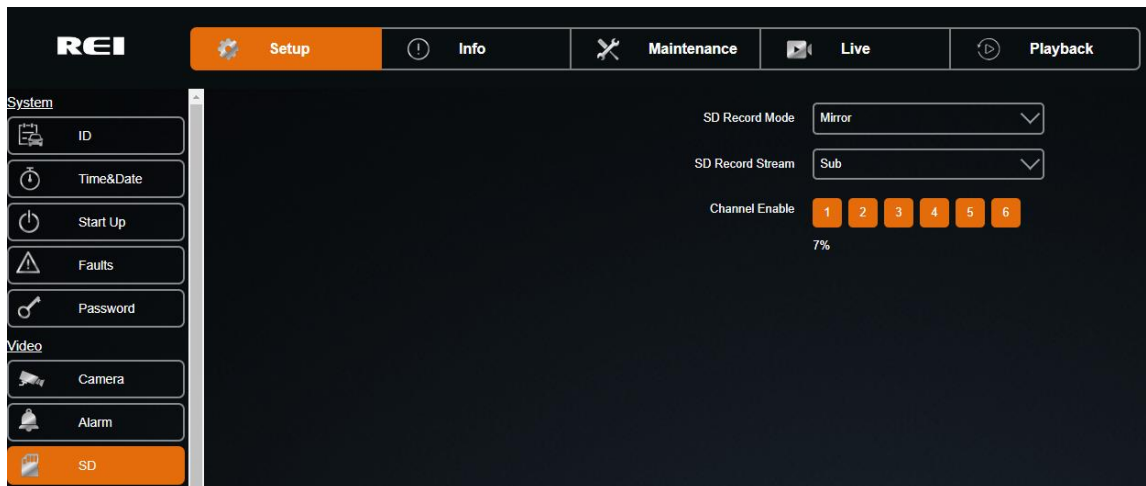

Figure 39: SD Setup

SD Record Mode: Select Alarm or Mirror

Alarm: Records only alarm video to the SD card.

Mirror: Records video to the SD card continuously.

SD Record Stream: Select Main or Sub

Main: Record high quality stream per the camera settings in Setup/Camera menu.

Sub: Record smaller stream per the settings in the Setup/Sub-Stream menu.

Channel Enable: Select the cameras to record to the SD card.

HD6-Series Mobile DVR

Sub-Stream Menu

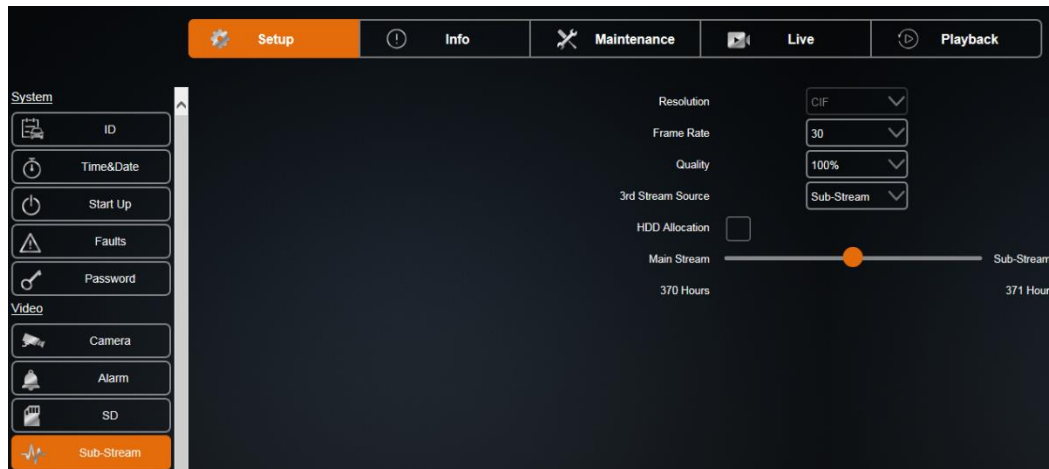

Figure 40: Sub-Stream Setup

Resolution: The resolution of the sub-stream (fixed at CIF).

Frame Rate: The frame rate of the sub-stream. Ranges between 1 and 30.

Quality: The quality (bit rate) of the sub-stream. Ranges between 10% and 100% of target bit rate.

3rd Stream Source: Stream to use as the source of the I-Frame mode in Remote Web Live View.

HDD Allocation: Check box to allow a larger duration of the sub-stream to be recorded to the HDD.

Image Menu

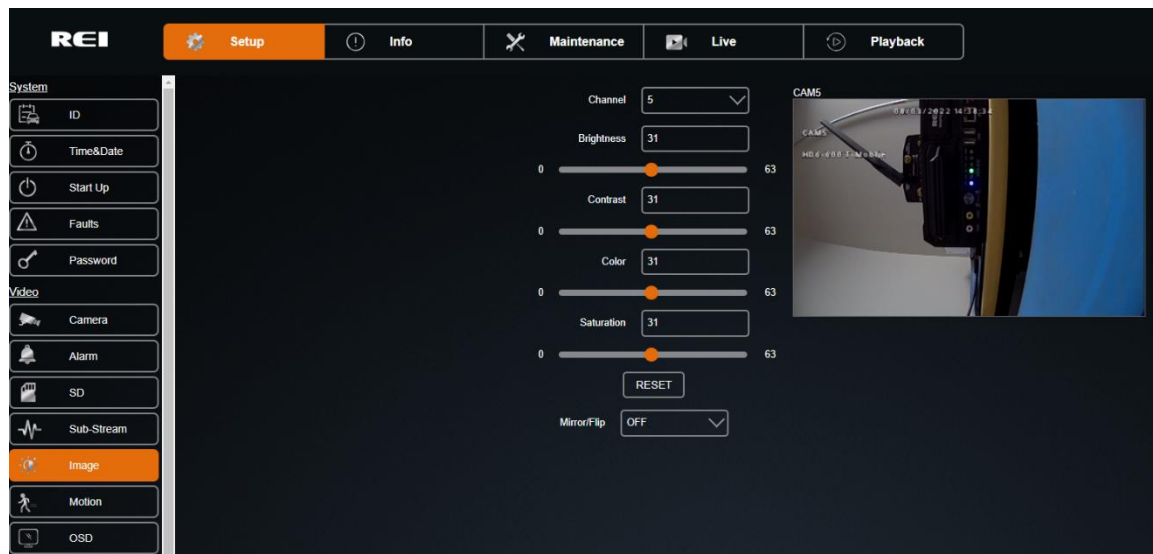

Figure 41: Image Setup

HD6-Series Mobile DVR

The Image function allows the user to adjust the camera signal to improve video quality. Individual channels can be adjusted to suit different cameras. The result is visible on the right side of the screen.

Channel: The channel that needs adjustment.

Brightness: Brightness adjustment for the video from 0-63.

Contrast: Contrast adjustment for the video from 0-63.

Color: Color adjustment for the video from 0-63.

Saturation: Saturation adjustment for the video from 0-63.

Mirror/Flip: A drop down that allows the mirror/flip the image of the selected channel.

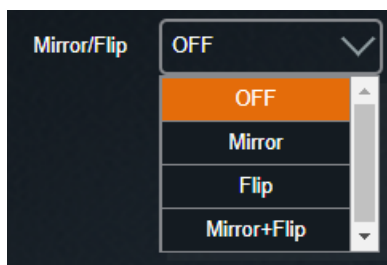

OFF: Default setting. Mirror and Flip not applied.

Mirror: Reverses the image. Back up cameras have a greater effect.

Flip: Turns the image upside down.

Mirror/Flip: Both mirror and flips effects applied.

The settings for each channel can be customized individually. The available options are Brightness, Contrast, Color, and Saturation. The settings range from 0 to 63.

Motion Menu

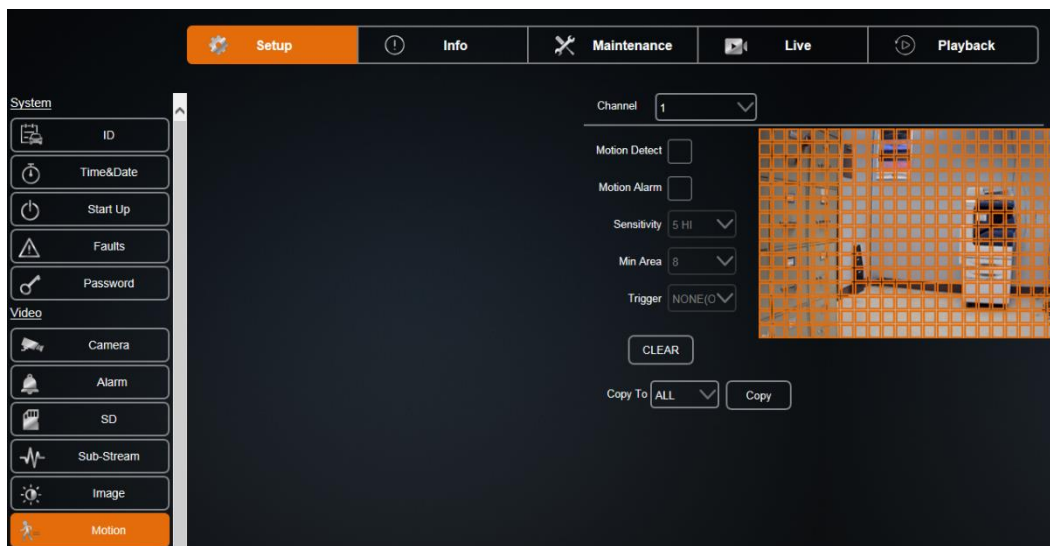

Figure 42: Motion Setup

HD6-Series Mobile DVR

Motion Setup menu controls the video motion detection system of the DVR. The user can enable camera motion detection individually. The system can be set to trigger a motion detection alarm. Sensitivity and area settings are adjustable for each camera.

Five options to customize each channel separately are available. The options are Motion Detect, Motion Alarm, Sensitivity, Min Area, and Trigger. Click Clear to start over.

Motion Detect: Enable motion detection for the selected channel.

Motion Alarm: Trigger alarm upon motion detection for the selected channel.

Sensitivity: Motion detection sensitivity within each square. Ranges between 1-LO and 5-HI.

Min Area: Minimum number of squares with motion required to trigger motion detection. Select 1, 2, 4, 8, 16, 32, or 64.

Trigger: Input that must be active to enable motion detection (INPUT 1-8, NONE equals always enabled).

Clear: Click to clear detection area.

Copy To: Copy the current settings to other cameras. The ranges are individual cameras 1 through 6, All, 1-6, or 5-6.

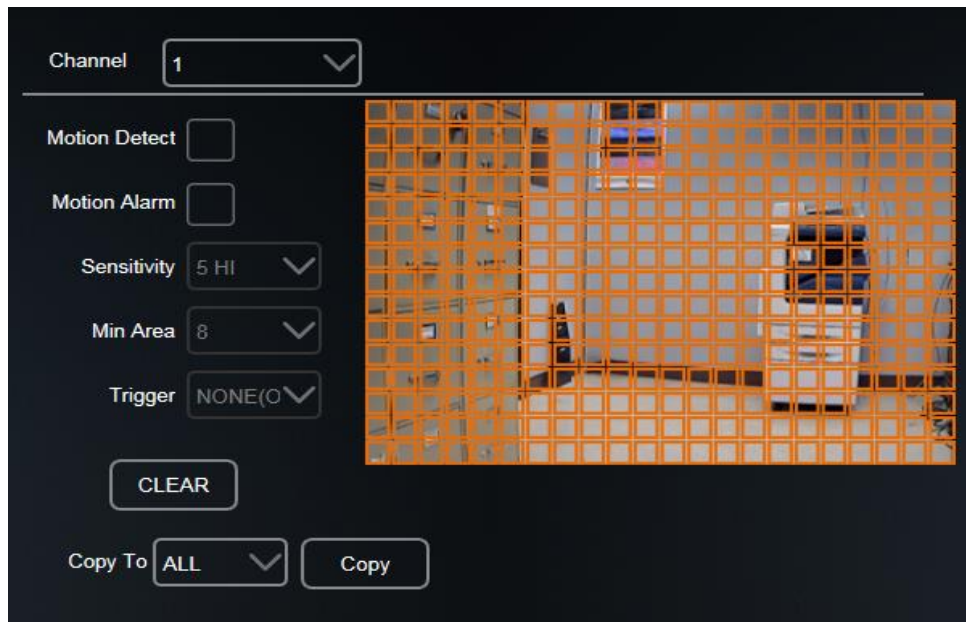

Figure 43: Motion Setup - Set Grid

Click and drag on the Set Grid screen to select the squares within the detection area.

OSD Menu

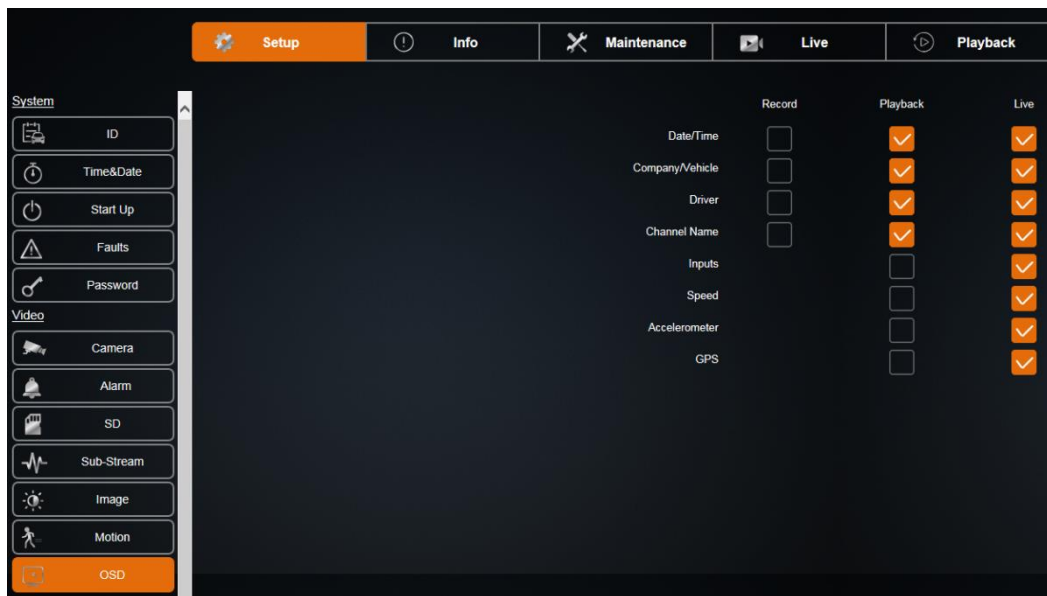

Figure 44: OSD Setup

OSD (On Screen Display): Divided into three subcategories Record, Playback, and Live.

Record: Selected data types will be recorded permanently over video.

Playback: Selected data types will be displayed during playback via monitor/mouse.

Live: Selected data types will be displayed during live viewing via monitor.

Input Setup



Figure 45: Input Setup

Input Setup: Contains all the settings to configure inputs from the DVR including Speed, Input, Accelerometer, and GPS Port Setup.

Speed Menu

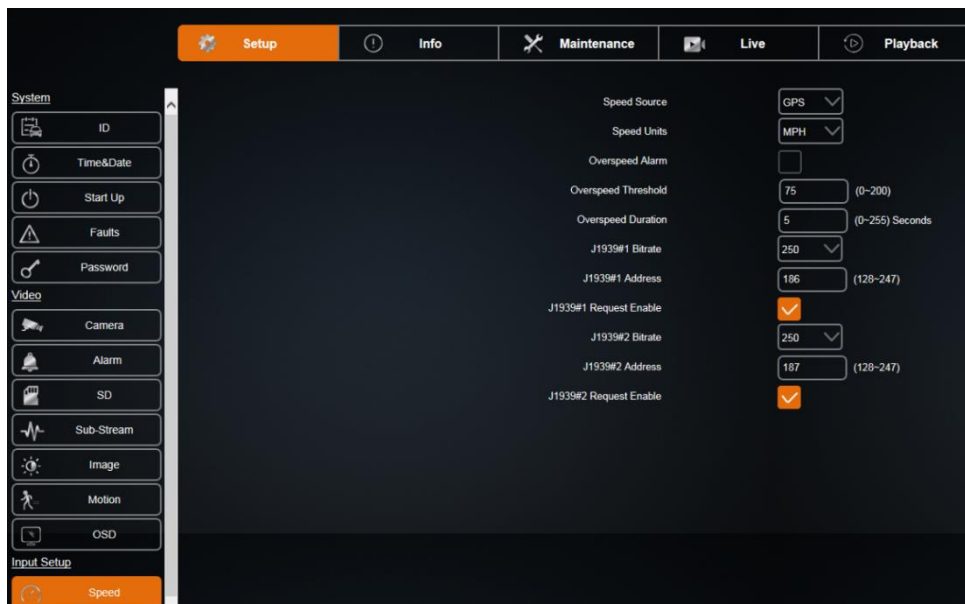

Figure 46: Speed Setup

Speed Setup Menu contains settings to change the speedometer source, speed unit, speedometer calibration, and high-speed alarm.

Speed Source: The DVR speed source; GPS, J1939#1 and J1939#2.

Speed Units: MPH and KMH speed units.

Overspeed Alarm: Triggers an alarm if the speed exceeds the Overspeed Threshold for the Overspeed Duration.

Overspeed Threshold: Minimum speed that triggers an alarm. 0-200.

Overspeed Duration: Time that speed must be over the threshold to trigger an alarm. 0-255 seconds.

J1939#1 & J1939#2: Contact REI support personnel for information about configuring these parameters (if necessary). Do not alter the initial settings unless instructed.

HD6-Series Mobile DVR

Inputs Menu

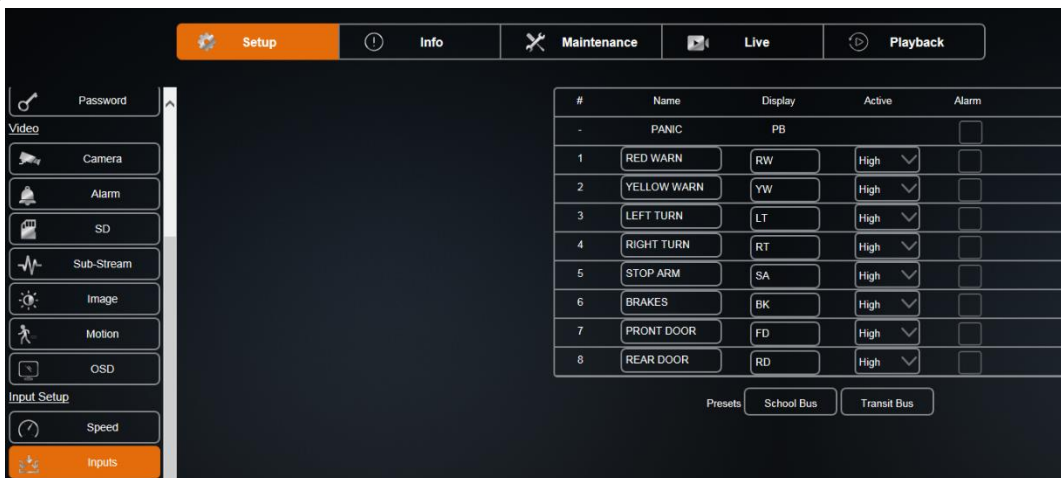

Figure 47: Inputs Setup

The Inputs Setup shows all the available inputs on the DVR. Each signal can be renamed, adjusted to active high/low, and set to trigger alarms when activated. There are two preset vehicle types to choose from: School Bus and Transit. When set to custom, each channel can have its own name and OSD abbreviation.

ALPR 1.0 Pod Mode should only be set if you are replacing your REI HD Series ALPR DVR with an REI HD6 DVR. Call REI tech support before using this mode.

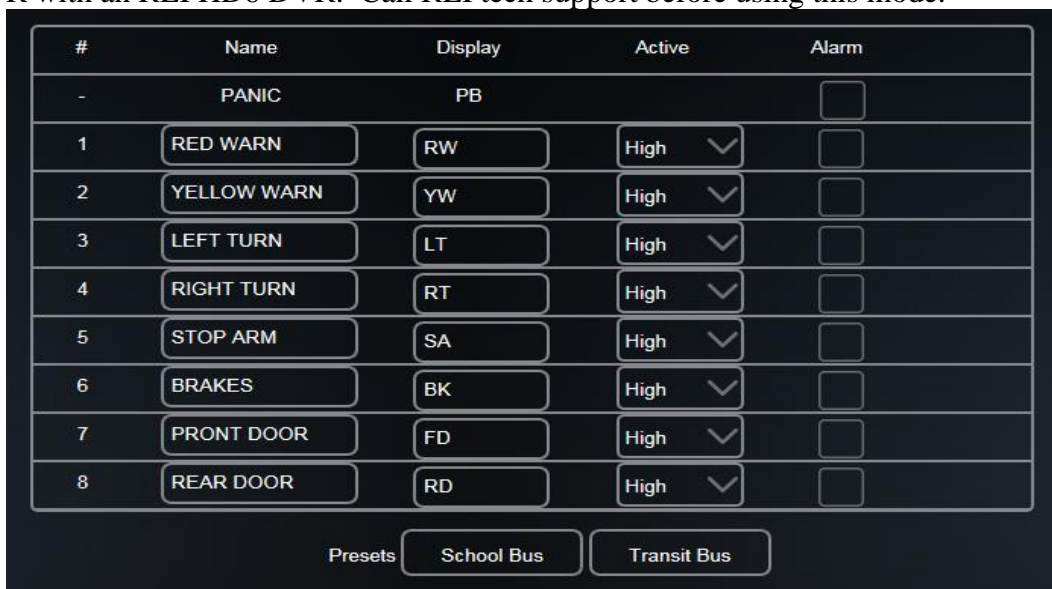

Figure 48: Input Setup - Custom

Input #: The input numbers that correspond to the input numbers on the DVR wiring harness.

Name: Name of the Input (16 characters or less).

Display: Abbreviation shown on OSD etc. (two characters).

HD6-Series Mobile DVR

Active: State which is considered active (low/ground or high/+ volt).

Alarm: Triggers alarm when the input is in the active state.

Presets: Preload input names and abbreviations for School Bus and Transit Bus.

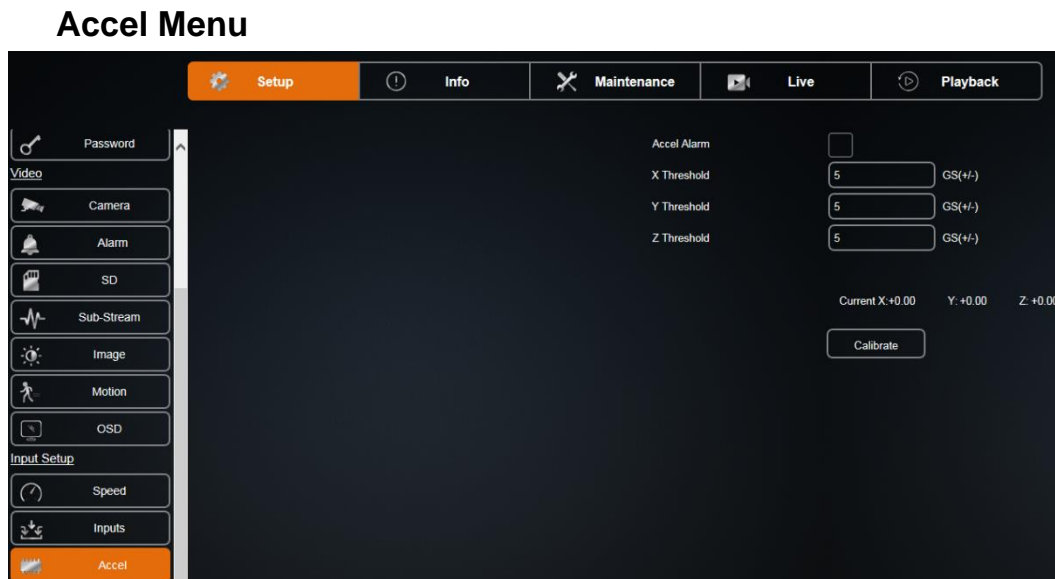

Figure 49: Accelerometer Setup

The Accel Menu gives user options to configure the accelerometer.

Calibrate Accelerometer: Accelerometer must be calibrated after installation.

Click the Calibrate button to calibrate the accelerometer.

Current Values: Current acceleration readings from the accelerometer.

Accel Alarm: Trigger an alarm when the X/Y/Z Threshold is exceeded.

X Threshold: Forward and backward acceleration/de-acceleration that triggers an alarm.

Y Threshold: Left or right acceleration/de-acceleration that triggers an alarm.

Z Threshold: Up and down acceleration/de-acceleration that triggers an alarm.

HD6-Series Mobile DVR

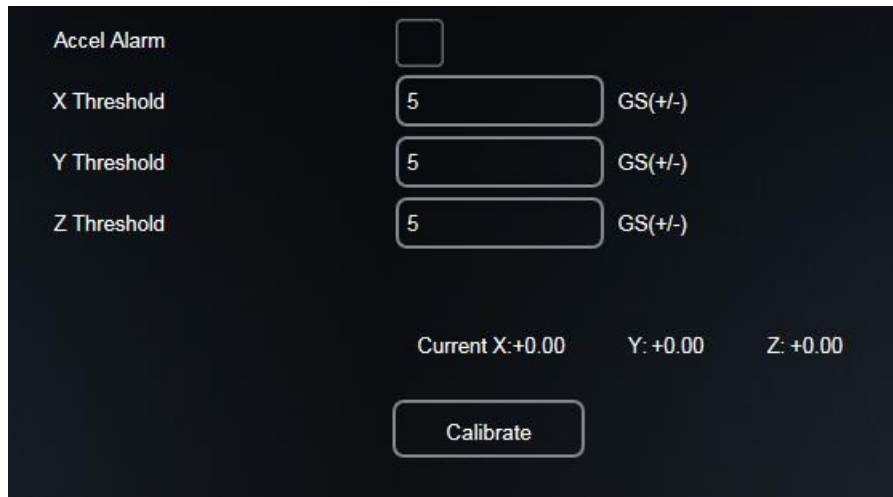

Figure 50: Accel Alarm

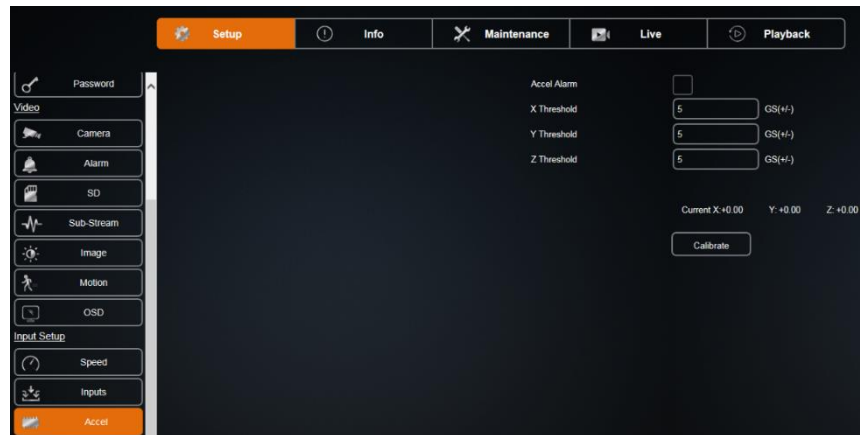

Figure 51: Accelerometer Threshold

GPS Port Menu

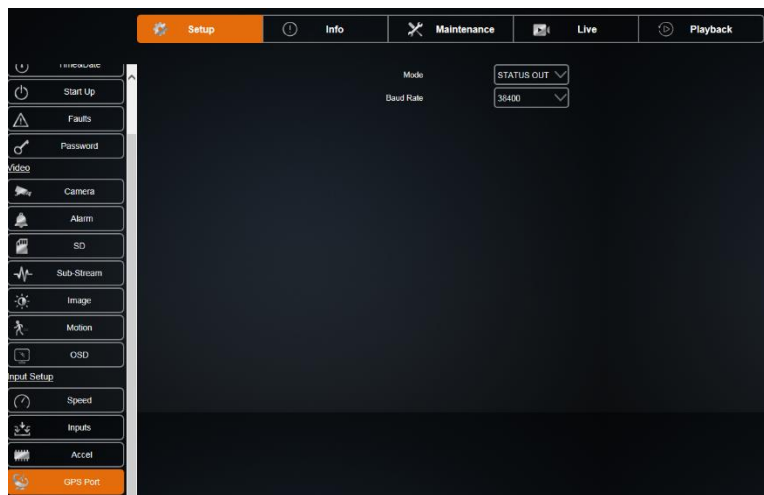

Figure 52: GPS Port

HD6-Series Mobile DVR

Mode: Set the mode of the GPS port Status Out or External GPS (input).

Baud Rate: Baud Rate of the GPS Port (4800 – 115200). The default setting for the REI GPS Module is 38400.

HD6-Series Mobile DVR

Network Setup



Figure 53: Network Setup

Network: The user can configure the DVR to connect to the network. It has inputs for WAN/LAN settings, server, WIFI, Cellular connections and Routes.

WAN/LAN Setup

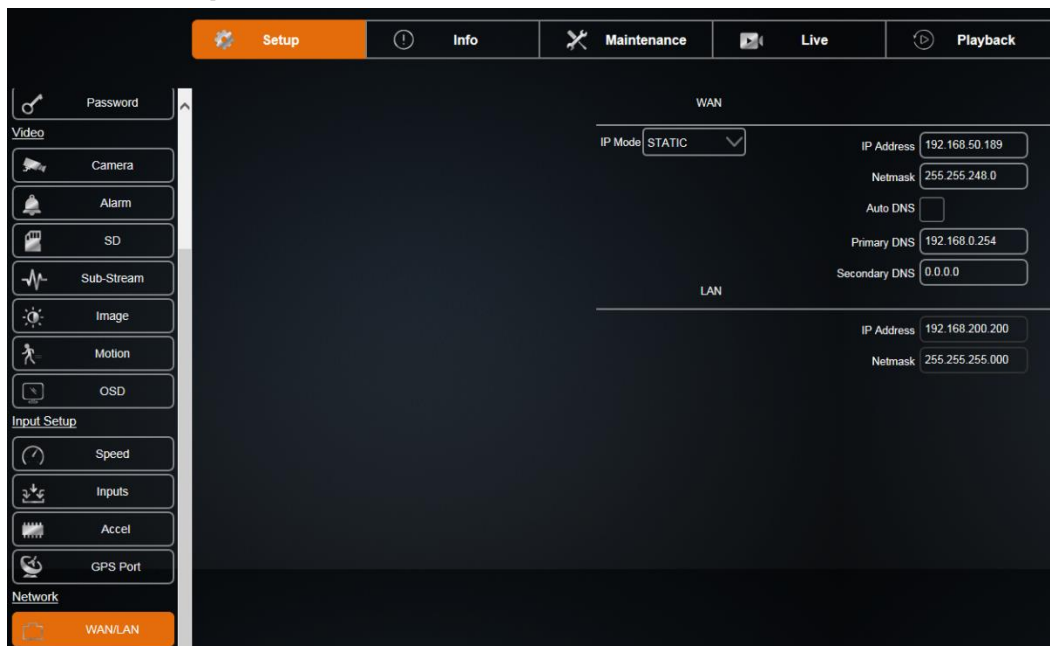

Figure 54: General Network Setup

WAN/LAN setup is where the user sets up the network configuration if using the Ethernet port located on the front and back of the DVR.

WAN

IP Mode: Static or Dynamic (DHCP) IP address.

HD6-Series Mobile DVR

IP Address: WAN or LAN IP Address.

Netmask: LAN Netmask.

Auto DNS: Use DHCP-provided IP address for DNS if checked.

Primary DNS: Primary DNS Server IP address for WAN

Secondary DNS: Secondary DNS Server IP address for WAN

Contact your IT specialists for assistance configuring this page.

Server

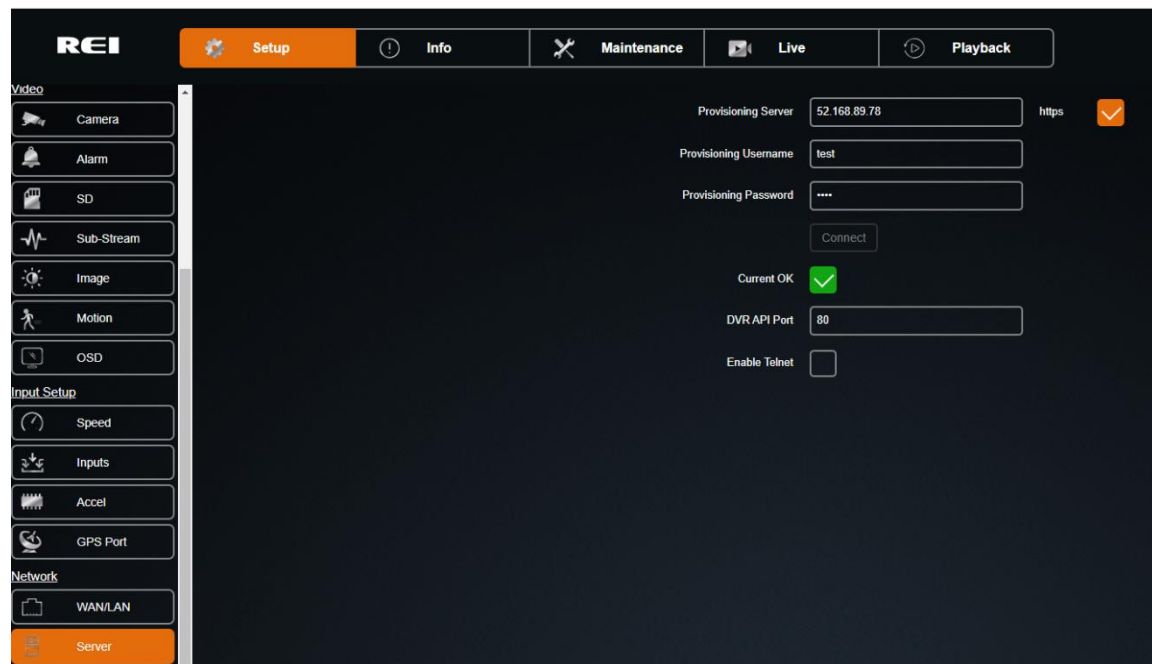

Figure 55: Server

Provisioning Server: Provisioning server IP address.

Provisioning Username: Username used to access the Provisioning server.

Provisioning Password: Password used to access the Provisioning server.

Click Connect after making Provisioning entries.

Current OK:

DVR API Port: DVR port used by ARMOR for access.

Enable Telnet: Enable Telnet access on DVR for remote administration. Note: Setting not saved. Clears on reboot.

HD6-Series Mobile DVR

WIFI Menu

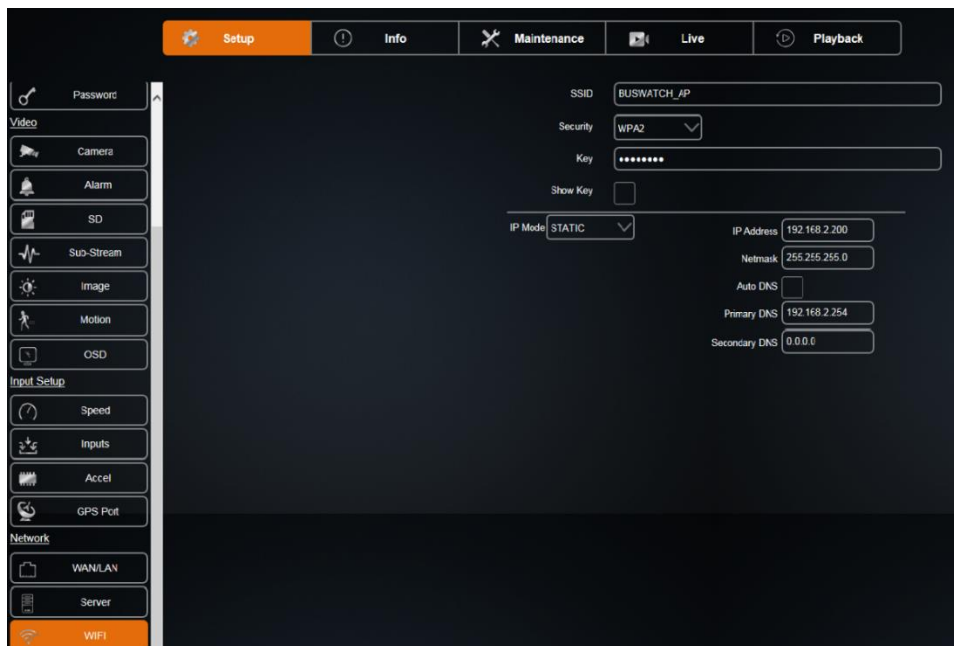

Figure 56: WIFI Setup

The Wireless Network settings allow the DVR to have a wireless connection. It also supports Auto IP detection for easy set up.

SSID: SSID of the access point of the WIFI network.

IP Mode: Static or Dynamic (DHCP) IP address.

IP Address: WIFI IP Address.

Netmask: WIFI Netmask.

Security: Security type used by WIFI network. It must match the access point setting.

Key: Security key used by WIFI network. It must match the access point setting.

Auto DNS: Use DHCP-provided IP address for DNS if checked.

Primary DNS: Primary DNS Server IP address for WIFI network

Secondary DNS: Secondary DNS Server IP address for WIFI network

Contact your IT specialists for assistance configuring this page.

HD6-Series Mobile DVR

Cellular

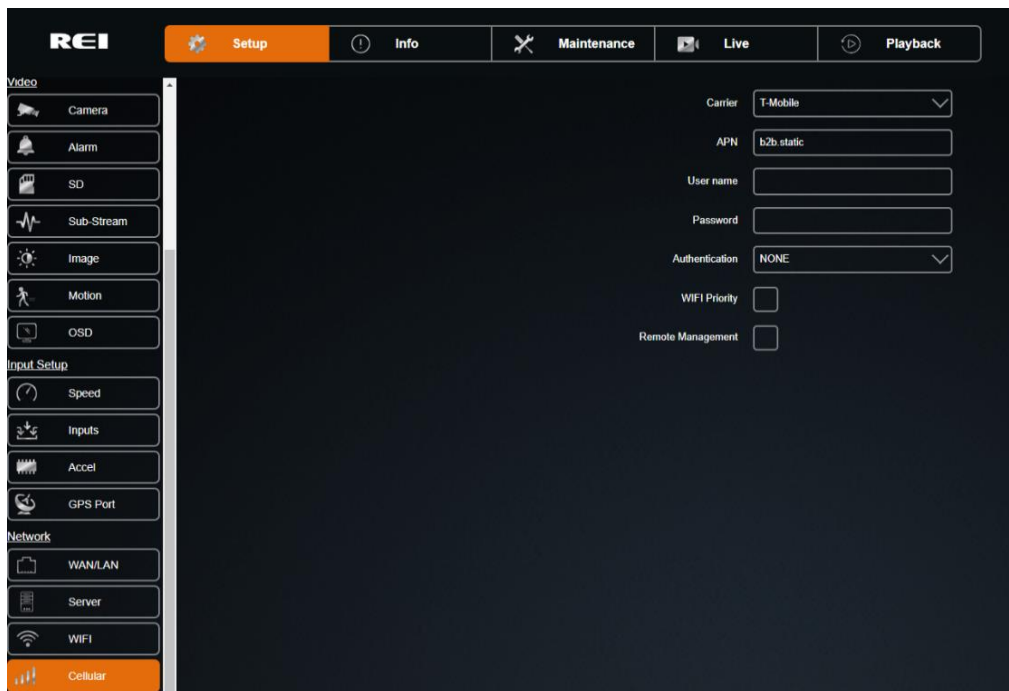

Figure 57: Cellular Setup

Configuration for internal cellular card. Applicable to cellular models only. Contact your IT specialists for assistance configuring this page.

Route

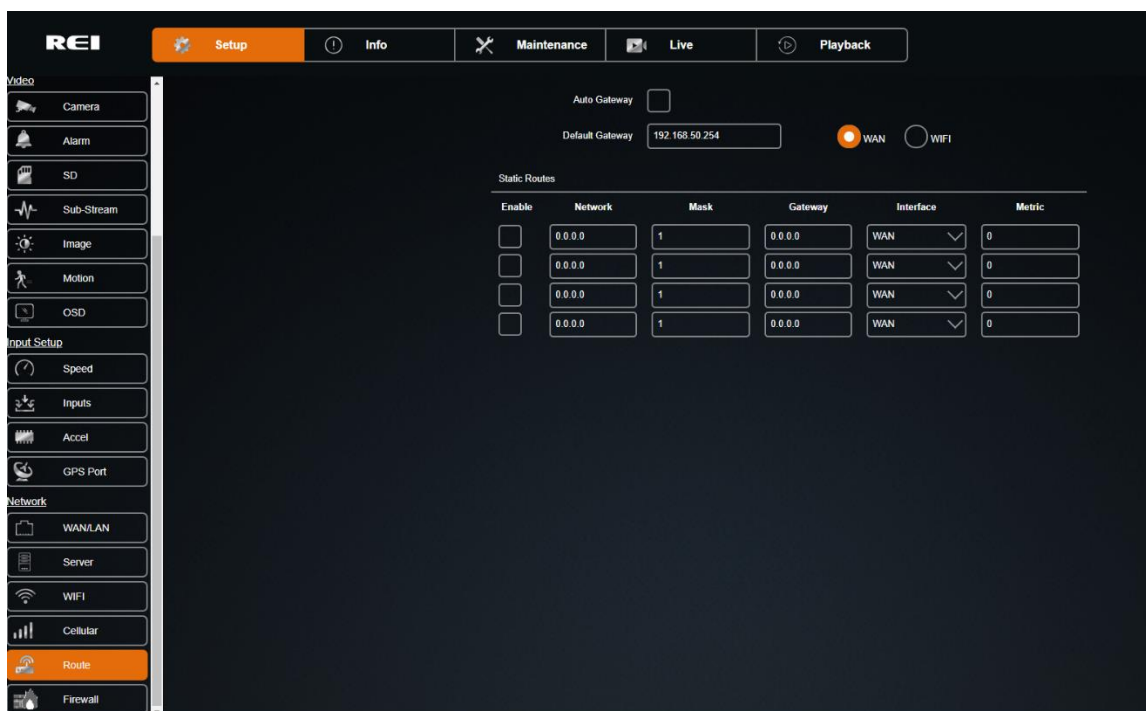

Figure 58: Route Setup

HD6-Series Mobile DVR

Configuration of default gateway and static routing. Contact your IT specialists for assistance configuring this page.

Firewall

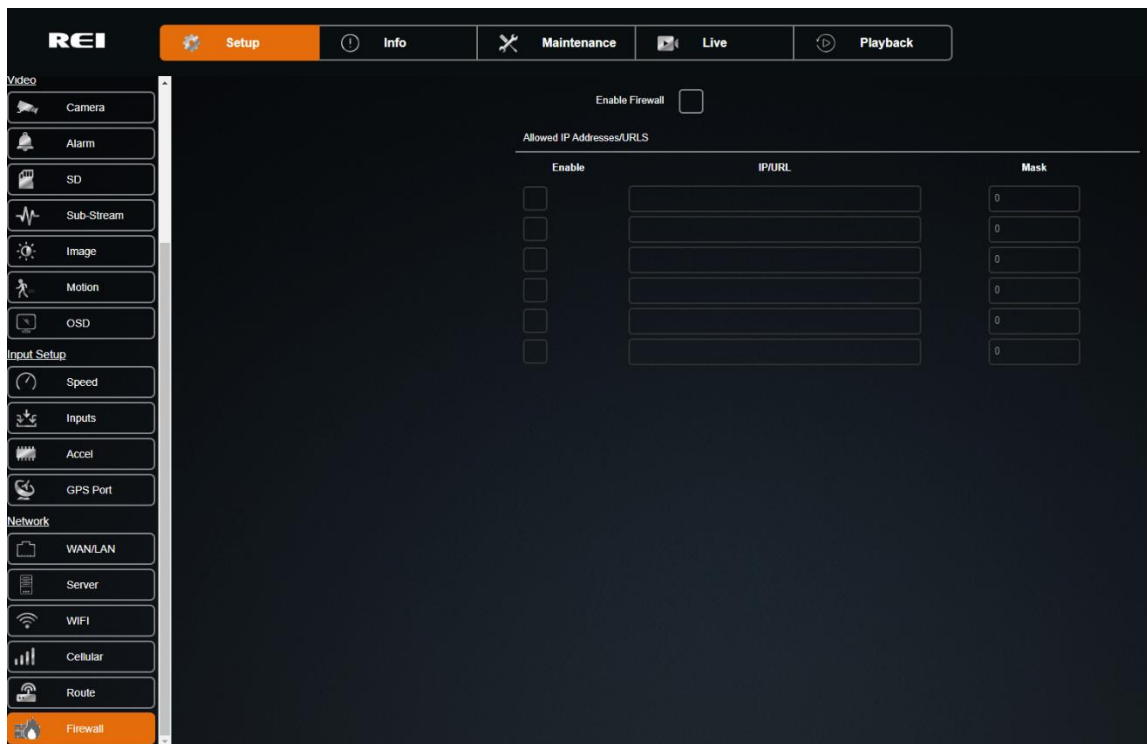

Figure 59: Firewall Setup

Enable Firewall: Select this check box to utilize firewall protection for selected IP/URL addresses.

Enable: Select this check box to enable firewall protection for the corresponding Allowed IP Addresses/URLs.

IP/URL: The IP address or URL that is selected for firewall protection.

Mask: Subnet mask.

HD6-Series Mobile DVR

Info

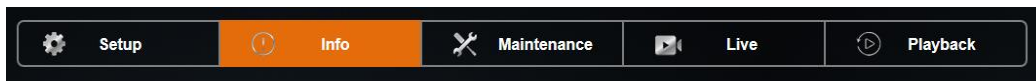

Figure 60: Info Menu

Info: Display only tab that displays status information of channels, active alarms, system information, WAN/Cell and WIFI connections, the system firmware versions, and logs.

Displayed data is displayed across eight subsections: Camera, Inputs, Alarms, System, WAN/Cell, WIFI, Versions, and Logs.

Camera

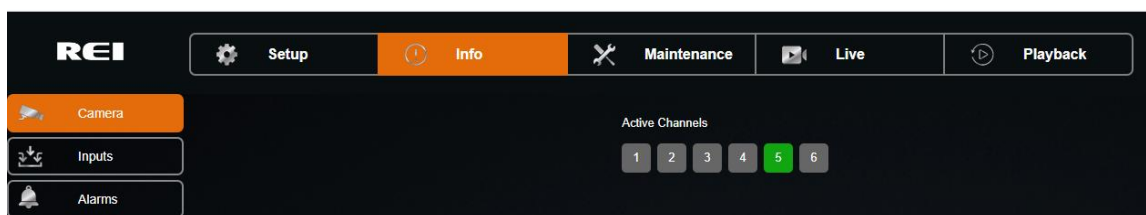

Figure 61: Camera Tab

Active Channels: Channels which have cameras currently connected and are enabled for recording.

Inputs

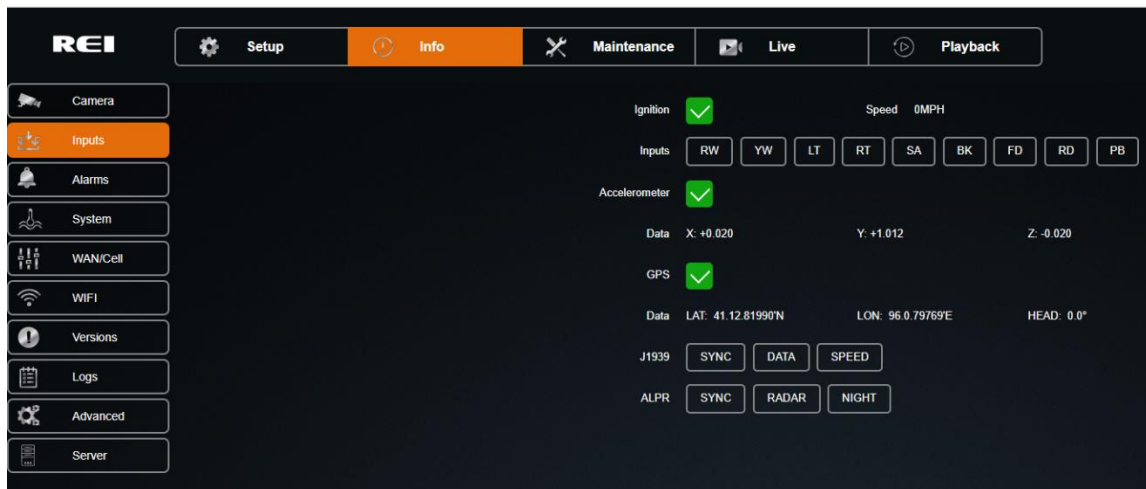

Figure 62: Inputs Tab

Ignition: Current state of vehicle ignition.

Speed: Current vehicle speed.

Inputs: Armor Action Inputs currently active.

Accelerometer: Accelerometer is connected.

Data X: Y: Z: Current Accelerometer data values.

HD6-Series Mobile DVR

GPS: Current GPS coordinates. Data: LAT/LON/HEAD

J1939: The Current status of the J1939 interface.

ALPR: The Current status of the optional ALPR 2.0 Pod.

Alarms

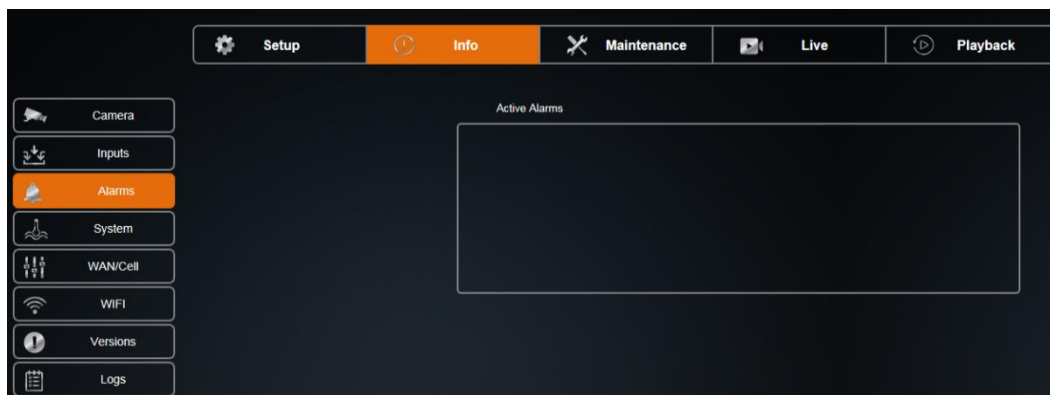

Figure 63: Alarms Tab

Active Alarms: Alarms that are currently occurring.

System

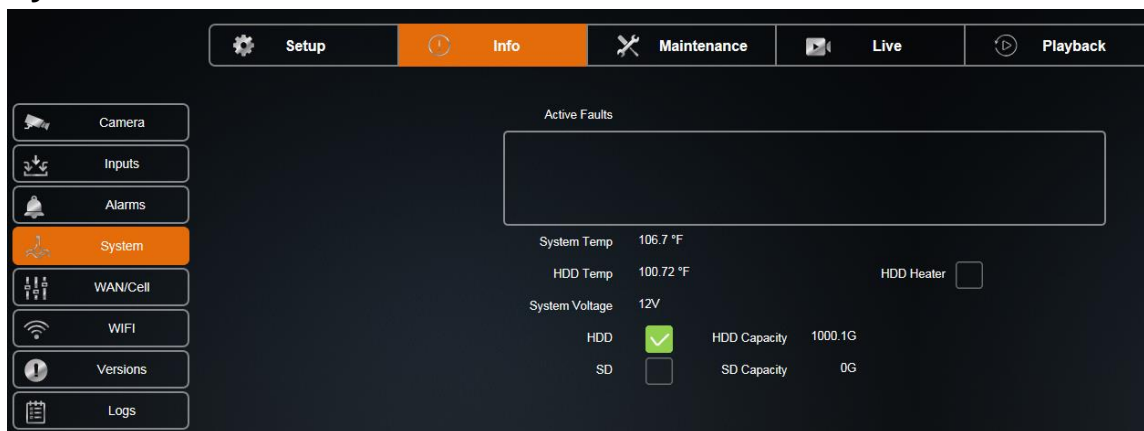

Figure 64: System Tab

Active Faults: Faults that have actively occurred.

System Temp: Current system temperature.

HDD Temp: Current hard drive temperature.

HDD Heater: HDD heater is On or Off.

System Voltage: Current system input voltage.

HDD/HDD Capacity: Size of the currently installed HDD.

SD/SD Capacity: Size of the currently installed SD card.

HD6-Series Mobile DVR

WAN/Cell

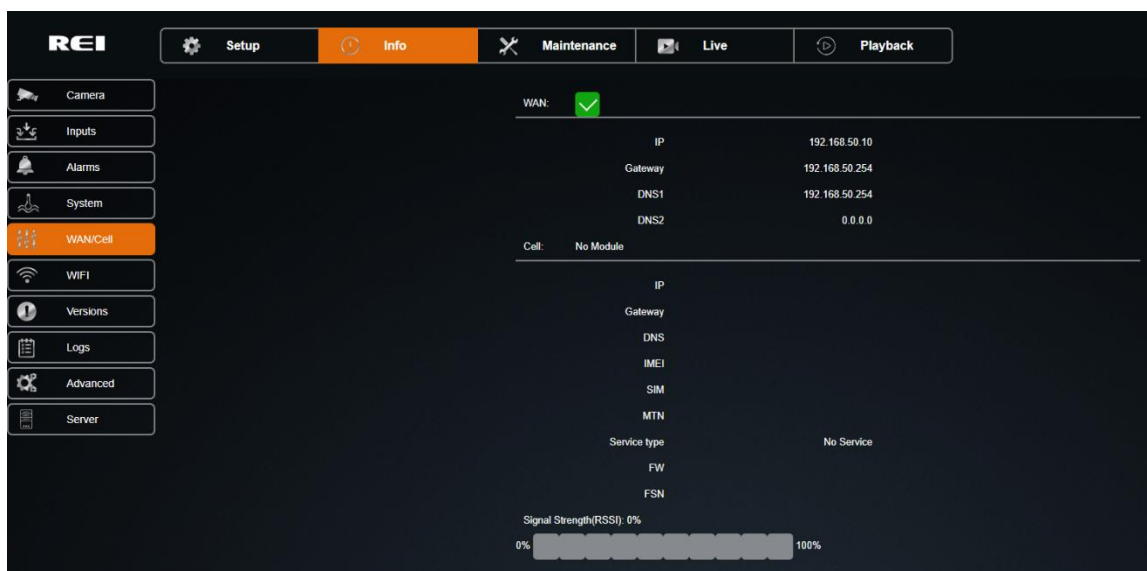

Figure 65: WAN/Cell Tab

WAN: Current IP address, Gateway, etc. of the WAN interface.

Cell: Current IP address, Gateway, etc. of the internal cellular interface.

Signal Strength (RSSI): Current signal strength of the internal cellular interface.

WIFI

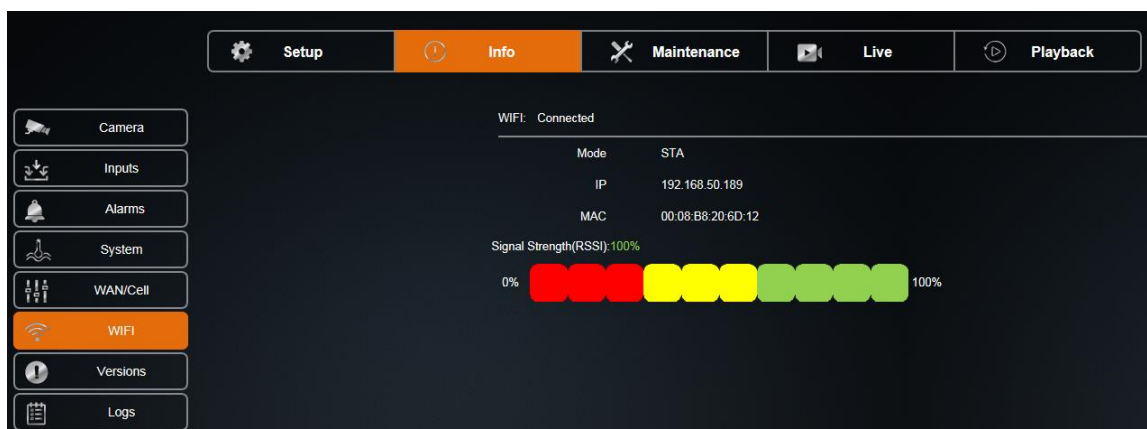

Figure 66: WIFI Tab

WIFI: Current mode and IP address of the WIFI interface.

Signal Strength (RSSI): Current signal strength of the internal WIFI interface.

HD6-Series Mobile DVR

Versions

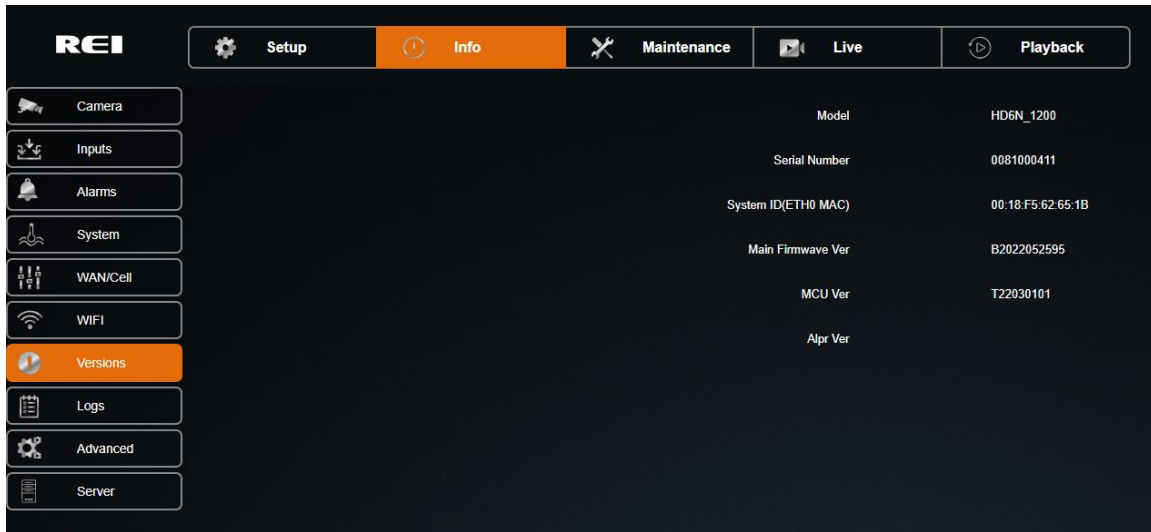

Figure 67: Versions Tab

Version of the Main/MCU Firmware, Serial Number, System ID, Model, MCU, and ALPR version.

Logs

Access to the system or fault logs by date.

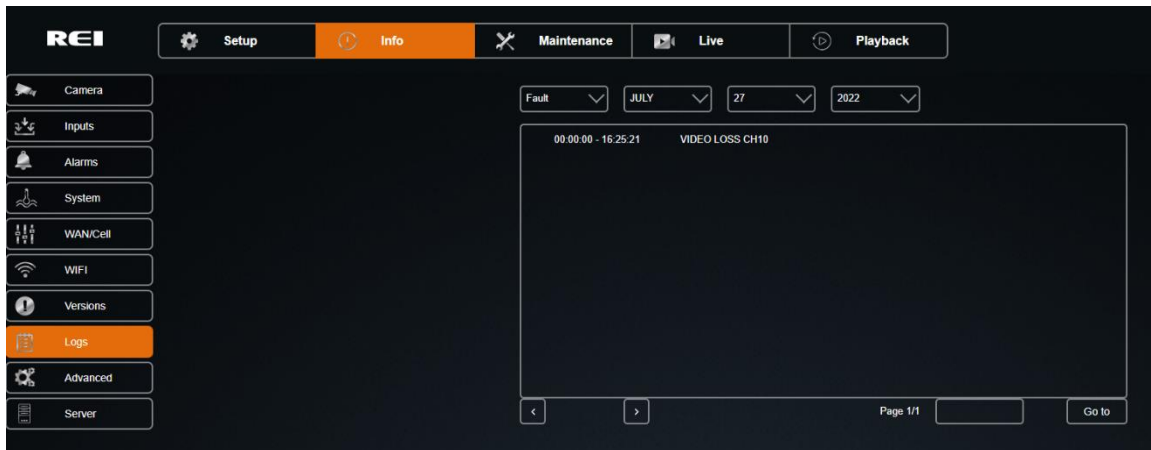

Figure 68: Fault Logs Tab

HD6-Series Mobile DVR

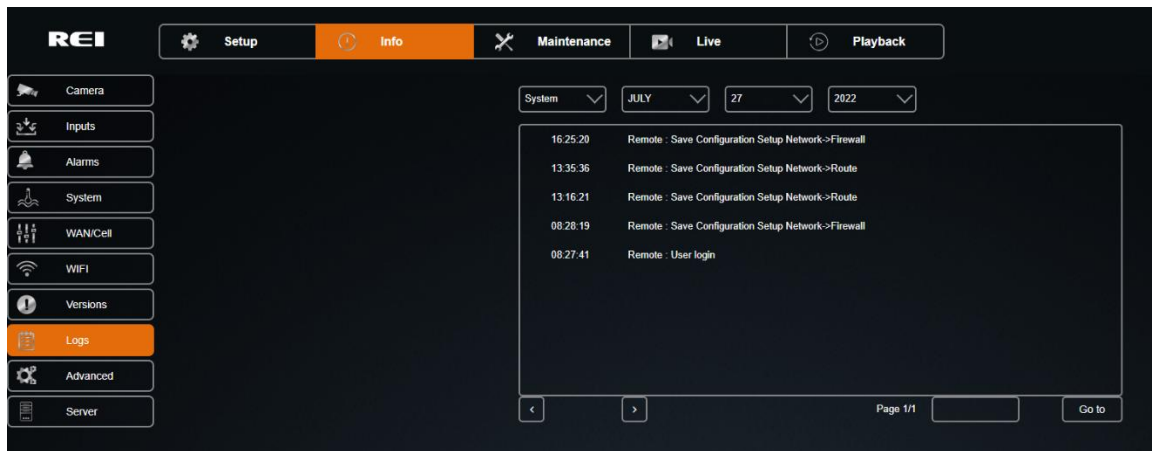

Figure 69: Logs – Search Result System Logs

Advanced

For internal use only.

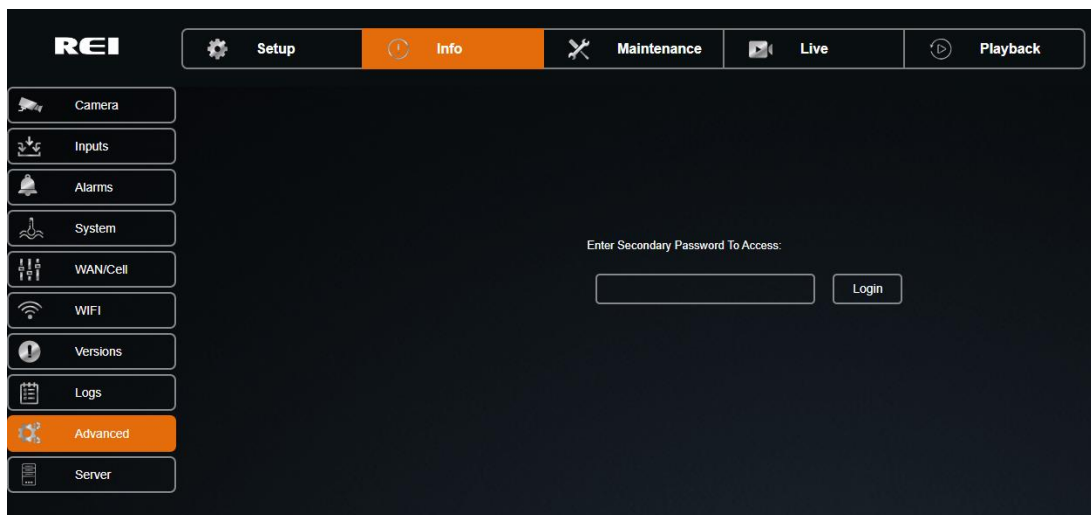

Figure 70: Advanced Tab

HD6-Series Mobile DVR

Server

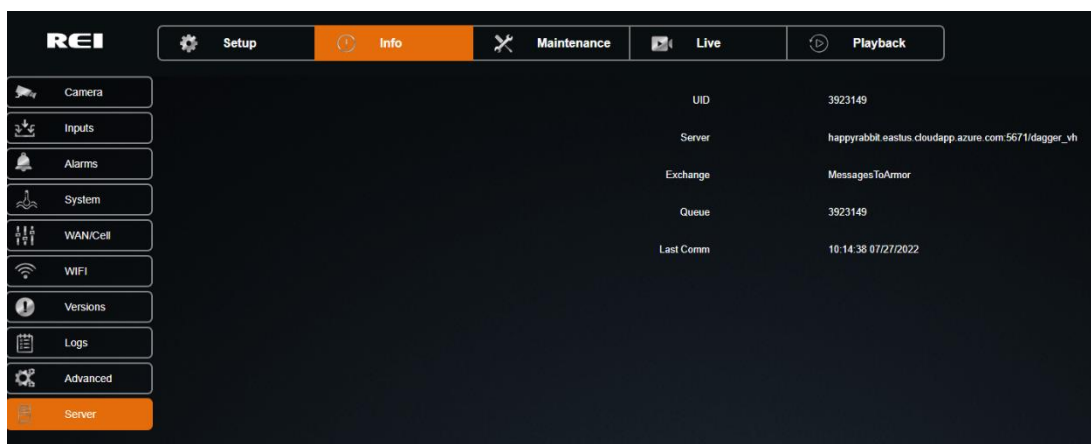

Figure 71: Server Tab

UID: User identification.

Server: Server identification.

Exchange: Details about the communication between the server and the DVR.

Queue: The identification of the user currently in the queue.

Last Comm: The most recent communication between the DVR and the server.

Maintenance

Maintenance allows upgrades to the firmware, import, or export the configuration, reset to defaults, or format the HDD, SD card, or USB media.

Firmware

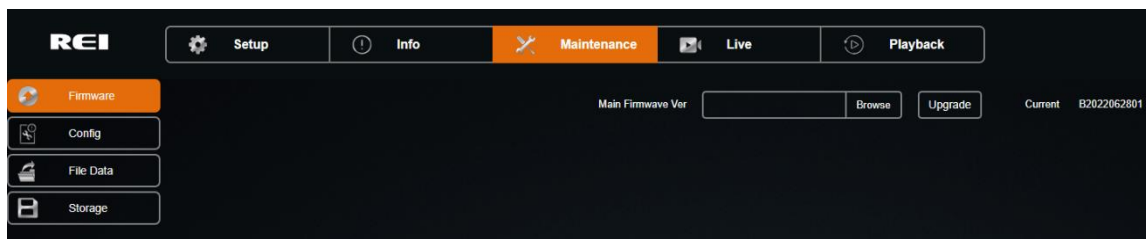

Figure 72: Upgrade Firmware

Click Browse to select the new firmware file from a location on your PC, click Upgrade to upgrade the firmware using the selected file.

HD6-Series Mobile DVR

Config Menu

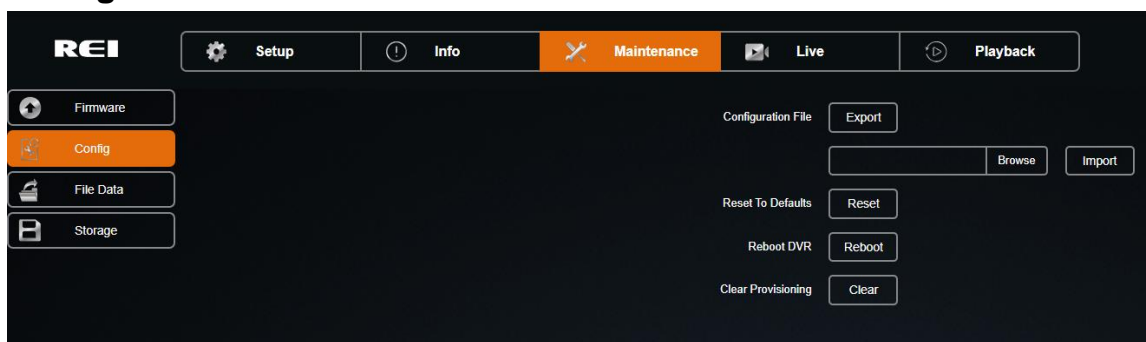

Figure 73: Export Configuration

Click Export to save the configuration to your PC.

Click Browse to select a previously saved configuration file from a location on your PC, click Import to apply the saved configuration. Note: Network settings and system ID will not be overwritten by this function.

Click Reset To Defaults to reset ALL configuration settings to the factory default. Note: This will change all network settings, including WIFI back to factory defaults.

Reboot DVR: Click Reboot to restart the DVR.

Clear Provisioning: Click Clear to delete all the server settings and allow a connection to another server.

File Data

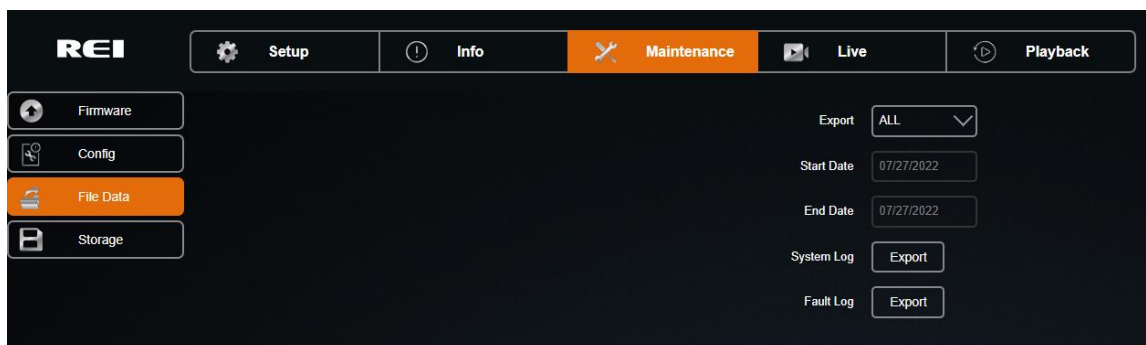

Figure 74: File Data Tab

Export: Select All or By Time from the drop down.

Start Date/End Date:

System Log: Log containing events and data. Click Export to copy.

Fault Log: Log containing errors and failures. Click Export to copy.

HD6-Series Mobile DVR

Storage



Figure 75: Storage Tab

Format/Clear HDD: Format/clear (erase) the HDD.

Format/Clear SD: Format/clear (erase) the SD.

Format/Clear USB: Format/clear (erase) the USB media.

Live



Figure 76: Live Menu

Live: Allows the user to view any or all cameras live.

Selecting Live opens a real-time view of the camera. The bar at the bottom of the screen has controls to select which channels are displayed, if info window is displayed, and to return to the Setup menu. Internet Explorer allows for all channels to be viewed simultaneously through ActiveX control. Chrome allows for only 4 up at a time.

Move cursor to the bottom of the screen to bring up the Channel bar. The following two buttons are at the left of the row of the channel buttons:

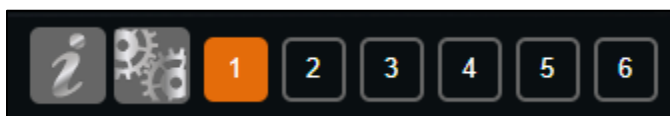

Figure 77: Channel Bar

Info Button



Click the button to display or hide the information panel as shown below.

HD6-Series Mobile DVR

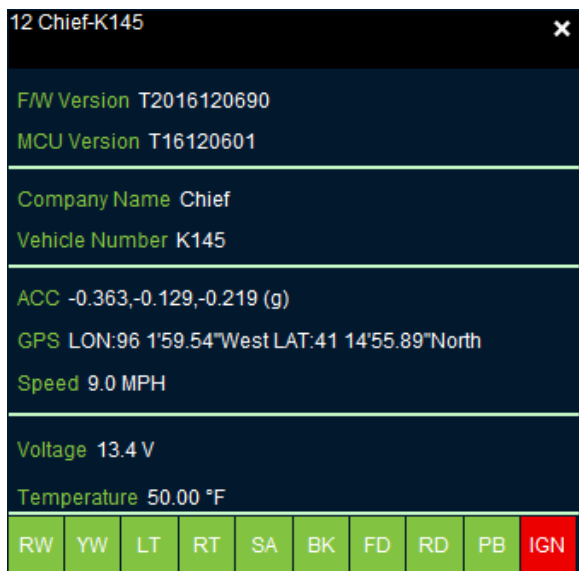

12 Chief-K145									
FW Version T2016120690									
MCU Version T16120601									
Company Name Chief									
Vehicle Number K145									
ACC -0.363,-0.129,-0.219 (g)									
GPS LON:96 1'59.54"West LAT:41 14'55.89"North									
Speed 9.0 MPH									
Voltage 13.4 V									
Temperature 50.00 °F									
RW	YW	LT	RT	SA	BK	FD	RD	PB	IGN

Figure 78: Sample Info Data Table

Settings button



Click this button to exit Live View and return to the Setup menu.

Channel Selection

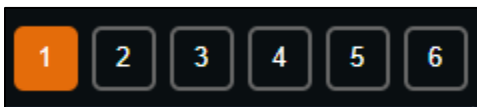

Figure 79: Channel Selection Buttons

Select individual channels for Live View.

Play Back



Figure 80: Playback Menu

Playback: Videos recorded on the HDD can be fully accessed from the Play Back menu. The user can search for videos by using the Time/Date Search function, and the Alarm Search function. Videos can also be backed up onto an external storage drive using the USB Backup function.

HD6-Series Mobile DVR

Video (Time/Date Search)

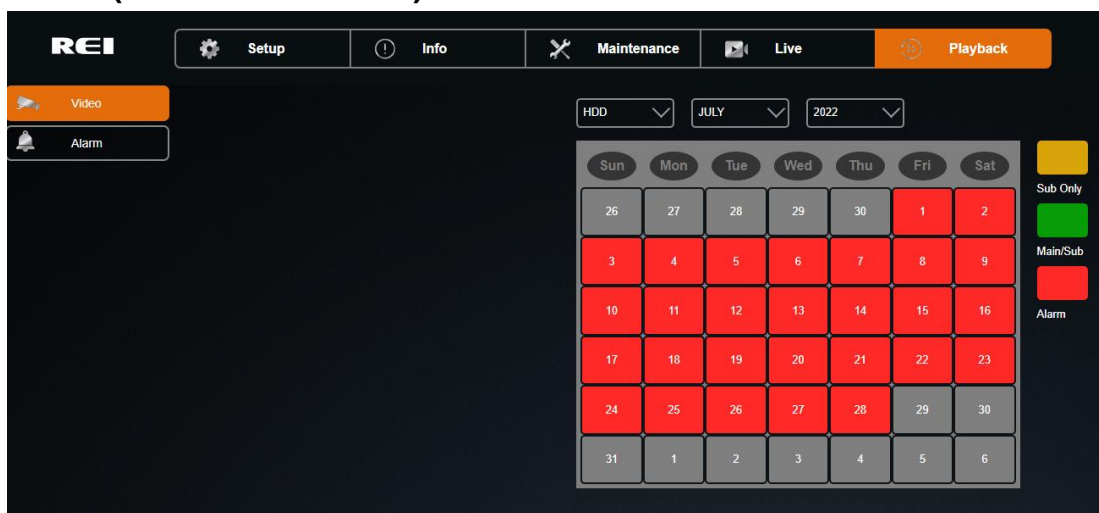

Figure 81: Video Tab - Time/Date Search for Date

The Time/Date Search function gives the user the ability to search videos by selecting the Time and Date.

The screen shows a calendar that contains videos.

Select the video storage device (HDD or SD), month, and year of the desired video.

The calendar will display all days in the selected year and month which contain video. If the day is green Main stream and Sub stream video is available for that day. If the day is yellow Sub stream video only is available for that day. If the day is red, the day contains Alarm video (Main and/or Sub stream).

Click the desired day on the calendar to start playback at the time of the earliest video on that day.

Alarm

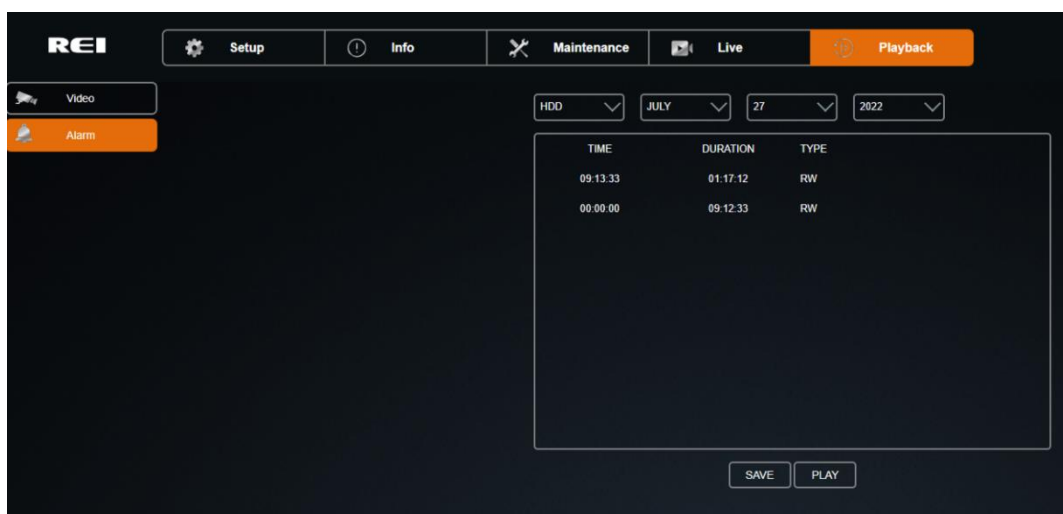

Figure 82: Alarm Tab - Alarm Search

HD6-Series Mobile DVR

The Alarm Search function gives the user the ability to search alarms from a list.

The screen shows a list of available alarms.

Select the video storage device (HDD or SD), month, and year of the desired alarm.

Select the desired alarm from the list of available alarms. Click Save to save the selected alarm to USB storage. Click Play to start playback of the alarm video.

HD6-Series Mobile DVR

FCC Statement

Changes or modifications not expressly approved by the party responsible for compliance could void the user's authority to operate the equipment.

This equipment has been tested and found to comply with the limits for a Class B digital device, pursuant to Part 15 of the FCC Rules. These limits are designed to provide reasonable protection against harmful interference in a residential installation. This equipment generates uses and can radiate radio frequency energy and, if not installed and used in accordance with the instructions, may cause harmful interference to radio communications. However, there is no guarantee that interference will not occur in a particular installation. If this equipment does cause harmful interference to radio or television reception, which can be determined by turning the equipment off and on, the user is encouraged to try to correct the interference by one or more of the following measures:

- Reorient or relocate the receiving antenna.
- Increase the separation between the equipment and receiver.
- Connect the equipment into an outlet on a circuit different from that to which the receiver is connected.
- Consult the dealer or an experienced radio/TV technician for help

This device complies with part 15 of the FCC rules. Operation is subject to the following two conditions (1) this device may not cause harmful interference, and (2) this device must accept any interference received, including interference that may cause undesired operation.